

# LISTA

DE PRECIOS DE REFACCIONES  
GRIFERÍA Y CERÁMICA

# 2022

NO. 39 FEBRERO



Refacciones Originales

**HELVEX** M.R.

garantía de calidad





R E F A C C I O N E S  
**GRIFERÍA Y CERÁMICA**

**ESTAMOS A TUS ÓRDENES**

[refaccioneshelvex.com.mx](http://refaccioneshelvex.com.mx)



(55) 8071 7454



(55) 5333 9421

Refacciones Originales

**HELVEX**<sup>M.R.</sup>

garantía de calidad

Refacciones Originales



garantía de calidad

Somos el **respaldo**  
de tu inversión

- Contamos con la variedad más amplia del mercado
- Nuestras refacciones son de fácil instalación



Al utilizar **Refacciones Originales Helvex**  
aseguras la garantía del producto



- 02** LLAVES Y MEZCLADORAS
- 12** ACCESORIOS
- 14** COLADERAS
- 17** VÁLVULAS Y VARIOS
- 22** FLUXÓMETROS
- 29** REGADERAS
- 33** ESPECIALES
- 34** CERÁMICOS
- 36** HOJAS DE REFACCIONES CERÁMICAS

**GUÍA TÉCNICA**











- 77** CARTUCHOS
- 83** ÉMBOLOS
- 86** VALVEX
- 89** AIREADORES
- 95** ECONOMIZADORES DE REGADERA
- 97** COLADERAS
- 107** MANTENIMIENTO

**DISTRIBUIDORES**

















- 108** DISTRIBUIDORES AUTORIZADOS

# LLAVES Y MEZCLADORAS















Modelo	Descripción	Precio	Modelo	Descripción	Precio
 RH-002	O'ring 2-012	\$ 5.09	 RH-010	O'ring 2-111	\$ 3.09
 RH-003	Asiento fijo Val-Vex	\$ 8.14	 RH-011	O'ring 2-021	\$ 3.78
 RH-004	Casquillo guía Val-Vex	\$ 68.15	RH-012	Torre contratuercas cuerpo	\$ 133.70
 RH-005	Tornillo asiento Val-Vex 8-18 x 1/4"	\$ 3.77	 RH-016	Asiento vulcanizado Val-vex central	\$ 63.71
 RH-006	Asiento de hule Val-Vex	\$ 4.80	RH-021	Niple unión cuerpo triple	\$ 134.90
 RH-007	Casquillo deslizable izquierdo	\$ 64.99	RH-022	Tuerca cople cuerpo triple	\$ 95.35
 RH-008	Vástago elevador izquierdo	\$ 82.02	 RH-025	Tornillo Phillips No. 8-32 UNC x 1"	\$ 4.30
 RH-009	Rondana vástago Val-Vex	\$ 8.14	RH-026	Rondana polietileno maneral	\$ 5.03
			 RH-027	Tornillo Phillips No. 8-32 UNC x 1 1/4"	\$ 5.03
			 RH-038	Tornillo ranurado No. 8-32 UNC x 3/8"	\$ 2.80

# LLAVES Y MEZCLADORAS

Modelo	Descripción	Precio	Modelo	Descripción	Precio
 RH-041	Vástago elevador largo	\$ 161.92	 RH-126	Torre contratuerca chica	\$ 45.40
 RH-042	Tornillo Phillips No. 8-32 UNC x 1/2"	\$ 15.69	 RH-127	O'ring 2-018	\$ 4.43
RH-045	Tapón maneral diamante Cr	\$ 19.30	RH-129	Tuerca hexagonal cuerpo lateral	\$ 89.05
RH-049	Tapón "C" maneral Flair grande	\$ 84.36	RH-141	Torre contratuerca mediana	\$ 85.77
RH-050	Tapón "F" maneral Flair grande	\$ 84.36	 RH-144	Tapón de hule desagüe cadena	\$ 49.82
RH-051	Maneral Flair Tr	\$ 270.14	RH-152	Rejilla para contra desg. de lavabo	\$ 52.35
RH-052	Base maneral Flair grande	\$ 169.26	 RH-162	O'ring 2-205	\$ 3.17
RH-085	Tapón macho cuerpo duplex	\$ 61.87	RH-170	Empaque plano cuerpo central	\$ 12.82
RH-088	Tuerca contra desagüe lavabo	\$ 93.25	 RH-177	Rondana de hule para chapetón	\$ 24.04
 RH-089	Rondana polietileno contra lavabo	\$ 6.97	RH-178	Porta base maneral grande diamante	\$ 20.86
 RH-090	Empaque cónico contra lavabo	\$ 23.92	RH-206	Regadera para Bidet Cr	\$ 275.69
 RH-095	Asiento delrin para esfera	\$ 8.14	 RH-217	O'ring 2-118	\$ 5.03
RH-097	Tuerca sujetadora varilla	\$ 72.48	 RH-220	O'ring 2-115	\$ 4.43
 RH-102	Tornillo gancho elevador	\$ 3.78	 RH-227	Casquillo deslizable derecho Valvex	\$ 64.99
 RH-103	Tuerca para gancho elevador	\$ 0.90	RH-228	Vástago elevador Val-Vex derecho	\$ 82.02
RH-108	Casquillo desviador central	\$ 62.41	 RH-253	O'ring 2-011	\$ 2.53
RH-109	Rondana de latón tuerca unión	\$ 10.49			
RH-113	Asiento fijo Val-Vex central	\$ 11.96			
RH-115	Tuerca hexagonal espárrago	\$ 34.06			
RH-117	Separador cuerpo central	\$ 16.50			
RH-119	Espárrago largo	\$ 90.22			









# LLAVES Y MEZCLADORAS





Modelo	Descripción	Precio
RH-274	Tornillo Phillips No.8-32 NC x 9/16"	\$ 17.72
 RH-275	Tornillo No. 10-24 UNC x 3/4"	\$ 21.43
RH-276	Rondana cónica para desagüe	\$ 14.76
RH-277	Tuerca desagüe automático	\$ 113.44
RH-287	Rondana hule codo inferior desag tina	\$ 31.34
RH-290	Tubo codo inferior 1-1/2" x 6-7/8"	\$ 150.74
RH-296	Tubo unión para desagüe de tina	\$ 85.77
RH-299	Contra desagüe tapón y cadena	\$ 418.73
RH-302	Birlo de contracranasta	\$ 89.58
RH-306	Sello para contracranasta	\$ 21.49
RH-307	Rondana de hule contracranasta	\$ 52.99
RH-308	Rondana contracranasta	\$ 24.62
RH-311	Tubo unión contracranasta p/ fregadero	\$ 143.00
 RH-313	Vástago Val-Vex II largo 1" estriado	\$ 241.09
 RH-337	O'ring 2-114	\$ 3.78
 RH-345	O'ring 2-112	\$ 3.17
RH-356	Rondana delrin cpo lat.	\$ 4.86
 RH-365	Botón varilla elevadora Elite	\$ 88.74
RH-378	Rondana espárrago	\$ 5.03
RH-394	Espárrago largo	\$ 108.80
RH-399	Tornillo Phillips No.8-32 UNC-2a x 1"	\$ 18.84

Modelo	Descripción	Precio
RH-416	Vástago salida tina cr.	\$ 64.53
RH-417	Maneral chico Albatros palanca izq.	\$ 248.25
 RH-418	O'ring 2-017	\$ 5.03
RH-419	Espaciador de contracranasta	\$ 68.95
RH-423	Tuerca unión tubo contra	\$ 204.96
RH-424	Contratuerca del espaciador	\$ 146.95
RH-427	O'ring 2-029	\$ 19.58
 RH-443	Empaque de hule Val-Vex II	\$ 7.27
 RH-444	Asiento delrin Val-Vex II	\$ 13.53
RH-467	Torre contratuerca alta	\$ 128.02
RH-468	Vástago elevador corto izquierdo	\$ 73.80
RH-483	O'ring 2-224	\$ 6.97
 RH-502	Resorte Sal. Tina Elite	\$ 26.15
RH-529	Tornillo No. 8-32 UNC	\$ 4.43
RH-542	Sello Sal. Tina	\$ 36.52
 RH-612	Chapeton 1-1/8" c/cuerda p/man.11/8"	\$ 160.63
 RH-613	Tuerca 1-1/2" 24 UNC-2a	\$ 170.26
 RH-614	O'ring 2-124	\$ 7.99
RH-620	Espárrago 5/16" 18 UNC-2a	\$ 41.53
RH-621	Tuerca 5/16" 18 UNC-2b	\$ 39.18
RH-634	O'ring 2-009	\$ 11.96
RH-641	O'ring 2-136	\$ 8.78
RH-664	Adapt sal Antiqua	\$ 148.27
RH-667	Opresor No. 8-32 x 1/4"	\$ 7.23
RH-690	Torre contratuerca	\$ 112.16
RH-700	Espárrago corto	\$ 71.82



# LLAVES Y MEZCLADORAS

Modelo	Descripción	Precio
 RH-703	O'ring 2 -117	\$ 4.43
 RH-741	O'ring 2-016	\$ 2.29
RH-759	Botón maneral Europeo CR.	\$ 61.87
RH-799	Porta base maneral grande Flair	\$ 21.49
RH-827	Cuerpo Val-Vex II	\$ 102.54
RH-828	Vástago grande Val-Vex II	\$ 88.11
RH-829	Vástago chico Val-Vex II	\$ 79.12
 RH-830	Disco fricción Val-Vex II	\$ 57.41
 RH-831	Plato superior cerámica	\$ 62.33
 RH-832	Plato inferior cerámica	\$ 62.33
RH-834	Rondana vástago Val-Vex II	\$ 21.80
RH-854	Varilla elevadora 3/16" X 11"	\$ 218.27
RH-916	Chapetón monomando 15/8"	\$ 203.12
RH-916-S	Chapetón monomando 15/8" satin	\$ 223.49
RH-917	Tuerca monomando 15/8"	\$ 121.61
 RH-924	Gancho elevador contra	\$ 52.85
 RH-930	Tubo unión céspol y contra p/lavabo	\$ 203.61
RH-930-S	Tubo unión céspol y contra p/lavabo satin	\$ 226.28
RH-932	Extensión superior contra	\$ 231.61
RH-971	Empaque de teflón	\$ 24.04
RH-972	Empaque para cuerpo mezclador	\$ 44.02
RH-973	Empaque hule base roscada p/E-34	\$ 56.84
RH-1047	Empaque para cuerpo central	\$ 16.02
 RH-1048	Espárr. p/salida de cámara seca lav.	\$ 78.27
 RH-1065	Casquillo con buje para valvex central	\$ 103.53







Modelo	Descripción	Precio
RH-1077	Junta unión	\$ 49.33
RH-1109	Junta unión	\$ 36.76
RH-1130	Tornillo Phillips 8-32 x 1"11-16	\$ 5.77
RH-1140	Chap. deslizable para maneral Nuva	\$ 277.85
RH-1152	O'ring 2-014	\$ 5.57
RH-1169	O'ring 2-126	\$ 1.98
RH-1185	Casquillo de sujeción maneral	\$ 34.65
RH-1186	Extensión macho maneral Nuva	\$ 141.29
RH-1186-S	Extensión macho man. Nuva satin	\$ 155.45
RH-1187	Buje extensión macho para maneral	\$ 85.29
RH-1187-S	Buje extensión macho para maneral satin	\$ 93.87
RH-1188	Botón para maneral Nuva	\$ 60.78
RH-1188-S	Botón para maneral Nuva satin	\$ 66.86
RH-1193	Tuerca	\$ 64.00
RH-1237	Esfera p/casquillo Valvex central	\$ 5.97
RH-1242	Llave hexagonal 11/16"	\$ 92.05
RH-1264	Extensión para ensamble E-50	\$ 108.20
RH-1272	Tornillo de 8-32 UNC 2A x 3/4"	\$ 6.64
RH-1278	Chap. base para monomando Nuva	\$ 233.71
RH-1278-S	Chap. base para mon. Nuva Satin	\$ 257.08
RH-1279	Espárrago	\$ 114.97
RH-1280	Tuerca de sujeción monomando	\$ 92.95
 RH-1282	Separador cuerpo central	\$ 16.01
 RH-1284	Rondana de latón monomando	\$ 35.96
RH-1302	Empaque para varilla de desagüe	\$ 7.18
RH-1329	Chapetón salida monomando	\$ 237.27
RH-1329-S	Chapetón salida monomando satin	\$ 261.28
RH-1334	O'ring 2-019	\$ 2.92
RH-1380	Rondana de hule para mezcladora HM	\$ 3.47
RH-1382	Empaque para mezcladora lavabo HM	\$ 9.66
RH-1385	Empaque para chap. d mezcladora freg.	\$ 16.72
 RH-1393	Aireador para salida Nuva	\$ 226.39
 RH-1395	Llave para aireador	\$ 13.36
RH-1444	O'ring 2-120	\$ 6.62
RH-1451	Rondana de latón vulcanizada	\$ 136.82
RH-1453	Espárrago para salida de lavabo	\$ 219.34
RH-1458	Botón varilla elevadora Miura	\$ 145.50



# LLAVES Y MEZCLADORAS

Modelo	Descripción	Precio
 RH-1459	Espárrago grande salida Miura	\$ 233.76
RH-1463	Chapetón para maneral Miura	\$ 416.07
RH-1467	Tornillo sujeción maneral Voga y Argenta	\$ 84.29
RH-1471	Tuerca espárrago salida Miura	\$ 99.88
RH-1472	Rondana de latón salida Miura	\$ 19.29
 RH-1473	Separador cuerpo central	\$ 13.06
RH-1486	Llave hexagonal 1-1/4"	\$ 127.70
RH-1557	Tornillo especial 8-32 unc	\$ 56.53
RH-1598	Buje de plástico	\$ 39.01
RH-1613	Rondana delrín	\$ 20.86
RH-1620	Espárrago para monomando fregadero	\$ 426.71
RH-1636	O'ring 2-320	\$ 15.14
RH-1649	Boquilla para aireador E-300	\$ 88.91
RH-1661	Buje conector p/salida de lavabo y freg	\$ 20.53
RH-1662	Rondana antifricción p/salida lav y freg	\$ 31.70
RH-1730	Cuerpo para maneral Vértika	\$ 313.81
RH-1731	Chapetón cuadrado para maneral Vértika	\$ 285.31
RH-1732	Base chapetón para maneral Vértika	\$ 245.31
RH-1747	Contratuercas p/cpo. d/empotrar de reg.	\$ 49.69
RH-1762	Buje para salida de fregadero	\$ 7.80
RH-1765	Chapetón p/sal ens. freg. E-301, E-302 CR	\$ 292.00
RH-1767	Antifricción inferior para salida fregadero	\$ 5.49
RH-1778	Empaque para salida de fregadero	\$ 11.62
RH-1780	Empaque p/chapetón maneral Kúbica	\$ 3.77
RH-1782	Opresor Allen 5-40 UNC	\$ 16.02
RH-1783	Empaque p/chapetón de salida lav y freg	\$ 4.74
RH-1786	Extensión vástago maneral Konos	\$ 171.25
RH-1802	Tuerca para monomando fregadero	\$ 108.74
RH-1849	Espárrago p/mezc. lav. Acueducto Vértika	\$ 294.23
RH-1864	Tuerca conector para espárrago	\$ 55.29
RH-1868	Empaque p/base sal. lav. Acueducto Vértika	\$ 19.22
RH-1875	Chapetón p/maneral Magna cromo	\$ 403.36
RH-1876	Extensión palanca maneral	\$ 88.75
 RH-1889	Empaque para diafragma push de tina	\$ 26.81
RH-1913	Cuerpo contra rebosadero p/lavabo	\$ 316.68
RH-1914	Cuerpo contra p/lavabo SREB	\$ 316.68
RH-1943	Cúpula p/contra push de lavabo cromo	\$ 244.90
RH-1943-S	Cúpula p/contra push de lavabo S	\$ 269.44
RH-1944	Rejilla p/contra push de lavabo cromo	\$ 117.82
RH-1945	Extensión p/contra push de lavabo cromo	\$ 246.47

Modelo	Descripción	Precio
 RH-1946	Empaque p/contra push de lavabo	\$ 12.73
RH-1986	Tuerca de sujeción cartucho 25mm	\$ 88.71
RH-2006	Tuerca fijación de chapetón mon. lav. pared	\$ 154.25
RH-2008	Maneral p/monomando lavabo Vértika /Cr.	\$ 409.04
RH-2009	Tapa deslizante p/monomando lavabo	\$ 112.78
RH-2011	Pistón p/cartucho monomando de reg	\$ 181.19
RH-2016	Pistón p/monomando de lavabo acueducto	\$ 194.02
RH-2019	Tuerca fijación de porta. cart. mon. lav. pared	\$ 79.36
RH-2020	Empaque amortiguador	\$ 23.51
RH-2021	Rondana antifricción	\$ 16.26
RH-2022	Varilla ajuste mon. lav. pared acue-Vértika	\$ 191.33
RH-2023	Llave p/tuerca mon. lav. pared Vértika	\$ 45.02
RH-2036	Tornillo ajust. porta. cart. Vértika-Premier	\$ 30.30
RH-2038	Empaque neopr. mzc. lav. acueducto Vértika	\$ 11.86
RH-2118	Placa d/sujeción monom. freg. E-305	\$ 120.14
RH-2196	Empaque p/cuerpo de empotrar	\$ 7.99
 RH-2197	Llave p/aireador oculto M24x1	\$ 39.54
RH-2201	Opresor 8-32 UNC 2A x 0.18"	\$ 4.09
RH-2202	Empaque p/monomando con inserto	\$ 5.10
RH-2207	Empaque p/tapa sal. monom. d/lavabo	\$ 33.44
RH-2208	Filtro p/salida monom. lavabo	\$ 120.80
RH-2220	Opresor Allen 5-40 UNCX 0.125	\$ 8.35
 RH-2223	Llave p/aireador rectangular	\$ 49.52
RH-2272	Llave de instalación p/mon. de freg	\$ 145.26
RH-2284	Tubo unión p/contra lavabo 30cm	\$ 357.60
RH-2368	Empaque cónico salida integra	\$ 12.37
RH-2393	Inserto espárrago p/mezcladora	\$ 219.90
RH-2437	O'ring 2-221	\$ 2.76
RH-2446	Tuerca de sujeción de cartucho E-306	\$ 146.00
RH-2462	Empaque base para chapetón	\$ 20.85
RH-2470	Chapetón p/mezcladora de freg. HM	\$ 600.73
RH-2471	Chapetón p/contratuercas Valvex	\$ 133.54
RH-2520	Chapetón p/mezcladora M-1005	\$ 147.35
RH-2549	Cuerpo central tipo "Y"	\$ 216.22
RH-2605	Opresor 8-32 UNC 1-1/8#	\$ 38.71
RH-2616	Opresor 8-32 UNC X 1#	\$ 10.01
 RH-2657	Llave para mantenimiento ME-303	\$ 35.45
RH-2670	Opresor 8-32 UNC X 1/1	\$ 31.09
RH-2671	Tornillo cabeza de botón 5-40 x 1/4"	\$ 2.73

# LLAVES Y MEZCLADORAS

Modelo	Descripción	Precio
RH-2676	Rondana antifricción HM-37 HM-38	\$ 7.91
RH-2704	Conector M10 A3/8" p/mon. cocina	\$ 44.46
RH-2731	Emp. para monomando de lavabo	\$ 14.38
 RH-2736	Llave para aireador oculto 15/16"	\$ 31.37
RH-2739	Sello base monomando lavabo Piura	\$ 33.26
RH-2743	Empaque sello contra lavabo	\$ 13.15
RH-2747	Separador maneral M-1006	\$ 39.63
RH-2834	Rondana antifricción p/chap. de mon	\$ 20.00
SH-023	Varilla armada para contra Óptima	\$ 180.70
 SH-025	Cadena larga desagüe tapón	\$ 228.25
SH-029	Manija con chap. varilla arm. cromo	\$ 1,330.52
SH-035	Contra rej. tapón cadena	\$ 453.40
SH-036	Canasta y Buje arm.	\$ 167.14
SH-066	Medio Val-Vex izquierdo	\$ 161.76
SH-074	Chapetón tapón y cadena de tina	\$ 877.80
SH-089	Regadera man. para mon. E-35 y E-36	\$ 971.98
SH-097	Cadena corta desagüe	\$ 124.19
 SH-118	Tapón diafragma desagüe tina	\$ 227.52
 SH-127	Canasta con birlo y tapón	\$ 278.11
 SH-130	Juego chapetones master sin empaques	\$ 388.57
SH-130-S	Juego chap. master sin empaque S	\$ 446.86
 SH-131	Juego chapetones master con empaques	\$ 449.59
 SH-217	Maneral Mantiss armado	\$ 906.57

Modelo	Descripción	Precio
 SH-220	Extensión c/asiento p/cpo lateral	\$ 91.03
SH-237	Cuerpo lateral armado Val-Vex II	\$ 1,109.02
SH-251	Contra rejilla soldada	\$ 521.32
SH-253	Varilla elevadora armada cromo	\$ 340.22
 SH-257	Val-Vex V-II cierre disco cerámico	\$ 388.41
SH-258	Kit casquillo Val-Vex central	\$ 130.49
 RH-010 RH-127 RH-1065 RH-1237	O'ring 2-111 O'ring 2-018 Casquillo c/buje p val. central Esfera p/casquillo val. central	
SH-259	Kit casquillo Val-Vex izquierdo	\$ 81.23
 RH-005 RH-006 RH-007 RH-010 RH-127	Torn. asiento Val-Vex Asiento Val-Vex Casq. desliz. izq. Val-Vex O'ring 2-111 O'ring 2-018	
 SH-260	Val-Vex grande derecho mecanismo de casquillo	\$ 224.49
 SH-261	Val-Vex chico derecho mecanismo de casquillo	\$ 216.86
 SH-262	Val-Vex grande izquierdo mecanismo de casquillo	\$ 224.49

# LLAVES Y MEZCLADORAS

Modelo	Descripción	Precio	Modelo	Descripción	Precio
 SH-263	Val-Vex chico izquierdo mecanismo de casquillo	\$ 216.86	 SH-370	Cartucho monomando GDM lavabo 35mm Diam.	\$ 618.83
 SH-264	Val-Vex central	\$ 355.03	SH-372	Manguera 1/2 x H 3/8" x12" largo	\$ 136.91
 SH-265	Kit de refacción Val-Vex II grande cierre disco cerámico	\$ 396.84	 SH-373	Cartucho monomando para fregadero	\$ 862.29
SH-266	Kit casquillo Val-Vex derecho	\$ 81.23	 SH-374	Cartucho monomando Mantis	\$ 875.37
 RH-005	Torn. asiento Val-Vex		SH-383	Cubre taladros monomando cromo	\$ 534.74
 RH-006	Asiento Val-Vex		 SH-383-S	Cubre taladros monomando satin	\$ 588.65
 RH-010	O'ring 2-111		SH-392	Cpo. lateral arm. para mangueras	\$ 965.10
 RH-127	O'ring 2-018		SH-393	Cuerpo lateral con Val-Vex II	\$ 1,061.60
 RH-227	Casq. desliz. der Val-Vex		SH-394	Mang. Flex. 3/8" x 1/2" x 12	\$ 227.15
 SH-282	Aireador para salida sin seguro cromo	\$ 150.39	SH-398	Maneral monomando Novus arm. cromo	\$ 781.58
SH-282-L	Aireador para salida laca sin seguro	\$ 180.53	SH-412	Cuello ganso giratorio hospital cromo	\$ 1,070.71
SH-282-S	Aireador para salida satin sin seguro	\$ 180.53	SH-417	Maneral Sable cromo	\$ 726.22
SH-301	Tapón con O'ring para maneral Axiss	\$ 71.27	SH-462	Paquete codo y regadera Bidet	\$ 719.69
SH-306	Tapón acrílico con botón rojo y azul	\$ 69.41	 SH-694	Cabezal p/mon. de freg. E-37 y E-39	\$ 1,494.03
SH-316	Botón "C" para maneral Antiqua	\$ 82.02	 SH-696	Torre contratuerca con O'ring	\$ 49.83
SH-316-L	Botón "C" para maneral Antiqua laca	\$ 98.94	SH-700	Maneral Axiss armado	\$ 1,022.54
SH-317	Botón "F" para maneral Antiqua	\$ 82.02			
SH-317-L	Botón "F" p/man. Antiqua c/base y/ O'ring laca	\$ 98.94			
SH-318	Botón central Antiqua	\$ 82.02			
SH-321	Varilla elevadora con botón	\$ 386.55			
SH-336	Valvex master	\$ 354.06			
 SH-355	Kit botón europeo con O'ring cromo	\$ 64.87			





# LLAVES Y MEZCLADORAS

Modelo	Descripción	Precio
 SH-1075	Manguera retráctil. p/mon. freg. E-305	\$ 1,275.88
SH-1080	Cúpula armada p/contra tipo hongo	\$ 863.93
SH-1087	Botón armado p/maneral Premier	\$ 74.36
 SH-1091	Kit 5 pzas. aireador Spray 1.9 Lts/Min	\$ 802.64
 SH-1093	Reg. manual p/monomando E-306	\$ 1,201.28
 SH-1112	Aireador oculto para monomando de lavabo E-909	\$ 120.87
 SH-1114	Valvex V grande izquierdo cierre disco cerámico	\$ 340.00
 SH-1122	Aireador rectangular para monomando Vértika	\$ 424.88
SH-1123	Chapetón con empaques p/monomando	\$ 147.59
SH-1128	Maneral armado p/mon. de freg. E-305 Cr	\$ 636.63
 SH-1131	Cartucho armado lavabo a pared 35 mm	\$ 648.28
 SH-1134	Cartucho para monomando 25 mm	\$ 972.40
 SH-1135	Aireador oculto M24 x 1.6G STD 2.2 GPM	\$ 134.33

Modelo	Descripción	Precio
 SH-1143	Aireador rectangular PL-RC 32x 8 IT 02.3280.0	\$ 403.90
 SH-1154	Cartucho armado 25 mm con vastago metalico	\$ 474.81
SH-1168	Porta cartucho arm. p/mon. lav. Vértika	\$ 843.38
 SH-1187	Chapetón armado p/mon. de lavabo	\$ 152.56
SH-1195	Maneral arm. p/mon. de pared E-3011	\$ 551.09
SH-1200	Salida armada para fregadero	\$ 1,614.58
SH-1201	Kit empaques p/salida de fregadero	\$ 21.92
 SH-1225	Cabezal magnético monomando E-307	\$ 1,412.95
SH-1251	Manguera metalica engargolada mon. E-307	\$ 1,432.88
SH-1252	Ensamble palanca armada E-306	\$ 764.00
 SH-1254	Aireador oculto para monomando slim	\$ 79.37
SH-1295	Man. arm. p/mezcladora mon.	\$ 793.63
SH-1297	Maneral p/mon. lavabo E-914 y E-915	\$ 606.02
 SH-1308	Cartucho rotativo 28 mm. mon. Bamboo	\$ 462.39
SH-1310	Varilla con botón armado larga	\$ 370.23
SH-1310-S	Varilla con botón armado larga satin	\$ 425.75
SH-1324	Aireador rect. PLC-LC 32x1.5 GPM	\$ 482.08

# LLAVES Y MEZCLADORAS

Modelo	Descripción	Precio
SH-1336	Man. arm. p/mezc. M-1005 y MR-1005	\$ 840.39
SH-1338	Chap. arm. p/mezcladora MR-1005	\$ 308.62
SH-1339	Chap. p/mezcladora MR-1005	\$ 132.27
 SH-1343	Valvex II-F chico izquierdo cierre disco cerámico	\$ 388.43
 SH-1344	Valvex II-F chico derecho	\$ 388.43
SH-1357	Economizador p/mon. a pared	\$ 53.04
SH-1359	Kit de sujeción p/mon. E-309	\$ 93.80
SH-1360	Tapon con O'ring mon. E-308	\$ 194.20
SH-1369	Kit de llaves de mantenimiento	\$ 1,591.57
 SH-1376	Kit de Valvex II-A derecho cerámico	\$ 729.42
 SH-1377	Kit de Valvex II-A izquierdo cerámico	\$ 729.42
SH-1387	Maneral arm. p/mon Vertika	\$ 417.98
SH-1390	Maneral armado p/mon. d acueducto	\$ 518.26
SH-1390-S	Maneral armado p/mon. d acueducto S	\$ 595.98
SH-1393	Kit de empaques p/mant. TH-148	\$ 228.28
SH-1397-S	Salida p. monomando de cocina E-300 S	\$ 2,094.75
SH-1402	Maneral armado p/mezcl M-1006	\$ 946.06
SH-1405	Maneral armado p/mon Vertika EP-905	\$ 439.85
SH-1406	Maneral armado p/mon Mantis	\$ 906.57
SH-1407	Maneral armado p/mon EP-909	\$ 735.47
SH-1408	Kit emp. de suj. p/mon E-905, EP-905, EP-909	\$ 44.06
SH-1409	Kit emp. de suj. p/mon MP-1000, EP-2120, 914, 915	\$ 42.76
SH-1410	Maneral armado p/mon. EP-914, EP-915	\$ 587.61
SH-1411	Maneral armado p/mon. EP-99	\$ 1,139.91
SH-1412	Botón armado p/maneral de monomando	\$ 30.75
SH-1413	Kit de llaves de mant. p/mon.	\$ 276.45
SH-1415	Maneral armado p/mon Elegance	\$ 643.19
SH-1416	Kit de emp. suj. p/mezcl MP-03, MP03-1.9	\$ 53.22
SH-1417	Kit de emp. suj. EP-2114, EP2001-1.9	\$ 51.81
SH-1418	Kit de empaques sujeción EP-2115	\$ 36.99
SH-1420	Maneral arm. Albatros derecho	\$ 318.72
SH-1421	Maneral arm. Albatros izquierdo	\$ 318.72







Modelo	Descripción	Precio
 SH-1441	Aireador para cabezal magnético E-307	\$ 253.27
SH-1455	Kit contra rej y contra hongo lav s/reb	\$ 59.38
SH-1460	Aireador para salida electrónica 0.35 GPM	\$ 130.30
SH-1510	Maneral para monomando E-300	\$ 494.01
SH-1510-S	Maneral para monomando E-300 S	\$ 568.11
 SH-1541	Eje hexagonal armado E-300	\$ 135.36
SH-1559	Tapón con empaque E-300	\$ 72.69
 SH-1569	Cartucho KX D 45 mm	\$ 504.92
 SH-1598	Cartucho rotativo 25 mm	\$ 634.02
 SH-1612	Cartucho D 35 mm Ex35 TOP TRN	\$ 632.37
SH-1559	Tapón con empaque E-300	\$ 72.69
SH-1624	Kit contra inserto rejilla s rebosadero	\$ 40.92
SH-1625	Kit contra inserto push sin rebosadero	\$ 40.92
 SB-1011	Kit 5 piezas aireador oculto 5.67 Lts/min	\$ 1,333.11
 SB-1012 SB-1012-S	Kit 5 pzas. aireador lav. 8.31 L. X min. Kit 5 pzas. aireador lav. 8.31 L. X min. satín	\$ 953.07 \$ 1,104.22
 SB-1013	Kit 5 pzas. aireador lav. 8.31 L X min.	\$ 1,333.11
 SB-1014 SB-1014-S	Kit 5 pzas. aireador lav. 5.67 L x min. Kit 5 pzas. aireador lav. 5.67 L x min. satín	\$ 953.07 \$ 1,157.22

# ACCESORIOS



Modelo	Descripción	Precio	Modelo	Descripción	Precio
 RA-005	Jabonera sobreponer 101, 102 Clásica	\$ 50.27	RA-037	Unión para argolla	\$ 17.57
RA-009	Tornillo No. 8 x 1/4"	\$ 2.05	RA-039	Argolla p/toallero cuadrado 109 Clásica Cr	\$ 398.70
RA-014	Resorte para tubo portapapel	\$ 13.06	RA-041	Base accesorio 110-118 Clásica cromo	\$ 230.18
RA-016	Tubo interior portapapel 104	\$ 121.61	RA-042	Pija 10-16 tipo ABx2" cromo	\$ 21.11
RA-017	Tubo exterior portapapel cromo	\$ 91.84	RA-044	Tubo toallero 110 Clásica cromo	\$ 503.21
RA-021	Opresor No. 8 x 27/64"	\$ 4.64	RA-046	Tornillo unión tubo toallero cromo solera	\$ 43.69
RA-022	Tapón para toallero múltiple cromo	\$ 125.60	RA-047	Tornillo 8-32 UNC-2a x 3/8"	\$ 1.87
RA-022-S	Tapón para toallero múltiple satin	\$ 138.18	RA-076	Tornillo sujeción 1/4-20	\$ 70.69
RA-024	Base Accesorio 106, 107, 108 Clásica cromo	\$ 197.94	RA-087	Barra toallero 105 Clásica cromo	\$ 558.97
RA-028	Jabonera transparente 108 Clásica	\$ 17.97	RA-130	Ancla chapetón cromo	\$ 187.47
RA-534	Tapón toallero barra Antigua cromo	\$ 95.83	RA-220	Porta ancla base toallero	\$ 21.92
RA-534-S	Tapón toallero barra Antigua satin	\$ 105.42	RA-253	Tornillo 1/4" x 20 UNC x 1.09" cromo	\$ 66.68
RA-569	Soporte p/tubo portapapel cromo	\$ 128.73	RA-301	Opresor 1/4-20 UNC-2a x 3/16"	\$ 23.81
RA-608	O'ring 2-119	\$ 5.09	RA-315	Jabonera para 102 Clásica cromo	\$ 387.14
RA-614	O'ring 2-133	\$ 5.81	RA-316	Tuerca No. 8-32 NC x 3/8"	\$ 10.64
RA-618	Empaque cepillera y jab. Nuva	\$ 40.08	RA-345	Resorte de compresión	\$ 13.06
			RA-400	Opresor No. 8 23/64	\$ 11.75
			RA-437	Ancla para atornillar	\$ 18.61

# ACCESORIOS

Modelo	Descripción	Precio
 RA-619	Vaso cristal para cepillero Nuva	\$ 776.46
 RA-620	Vaso dispensador de jabón líquido para jabonera	\$ 476.24
 RA-621	Cristal para jabonera sencilla Nuva	\$ 560.23
RA-633	Anillo para jabonera y cepillera cromo	\$ 616.22
RA-637	Tornillo allen 8-32 x 5/16"	\$ 10.64
RA-640	Opresor allen 10-24 UNC x 1/4"	\$ 8.14
RA-644	Barra para toallero Nuva cromo	\$ 1,124.14
RA-648	Opresor allen 10-24 UNC 2Ax5/16" Al	\$ 10.64
RA-650	Tornillo allen No. 24-24 x 1 1/2"	\$ 12.67
 RA-652	Ancla para accesorios Nuva	\$ 187.94
 RA-726	Jabonera sobreponer para 208 Clásica II	\$ 61.29
RA-735	Resorte portapapel 215	\$ 21.36
 RA-741	Ancla para accesorios Miura	\$ 118.49
RA-790	Tornillo allen 10-24 X 3-8"	\$ 9.50
RA-791	Llave allen 5/32"	\$ 29.93
RA-796	Opresor allen 8-32 x 1/2"	\$ 8.93
RA-829	Tornillo p/lav. 5-40 X 0.45 logitud	\$ 2.64

Modelo	Descripción	Precio
 RA-867	Vaso cepillero de cristal Innovex	\$ 246.49
RA-919-AI	Opresor allen 10-24 UNC AI	\$ 2.62
RA-990	Ancla para accesorios	\$ 97.24
RA-1013	Opresor 8-32 UNC x 3/8	\$ 3.83
RA-1051	Base soporte para accesorios Nuva cromo	\$ 216.66
RA-1052	Soporte p/accesorio Nuva	\$ 578.74
RA-1063	Tornillo autorroscable 8-32	\$ 7.28
RA-1066	Ancla p/ accesorios y reg. manual Vértika	\$ 118.49
RA-1095	Ancla p/accesorios Magna	\$ 119.67
RA-1154	Ancla para accesorio Explora	\$ 21.36
RA-1197	Ancla para accesorio	\$ 133.21
RA-1208	Tornillo especial 1/4" -20 UNC x 0.450"	\$ 63.45

 SA-021	Tubo portapapel armado cromo	\$ 192.32
---	------------------------------	-----------









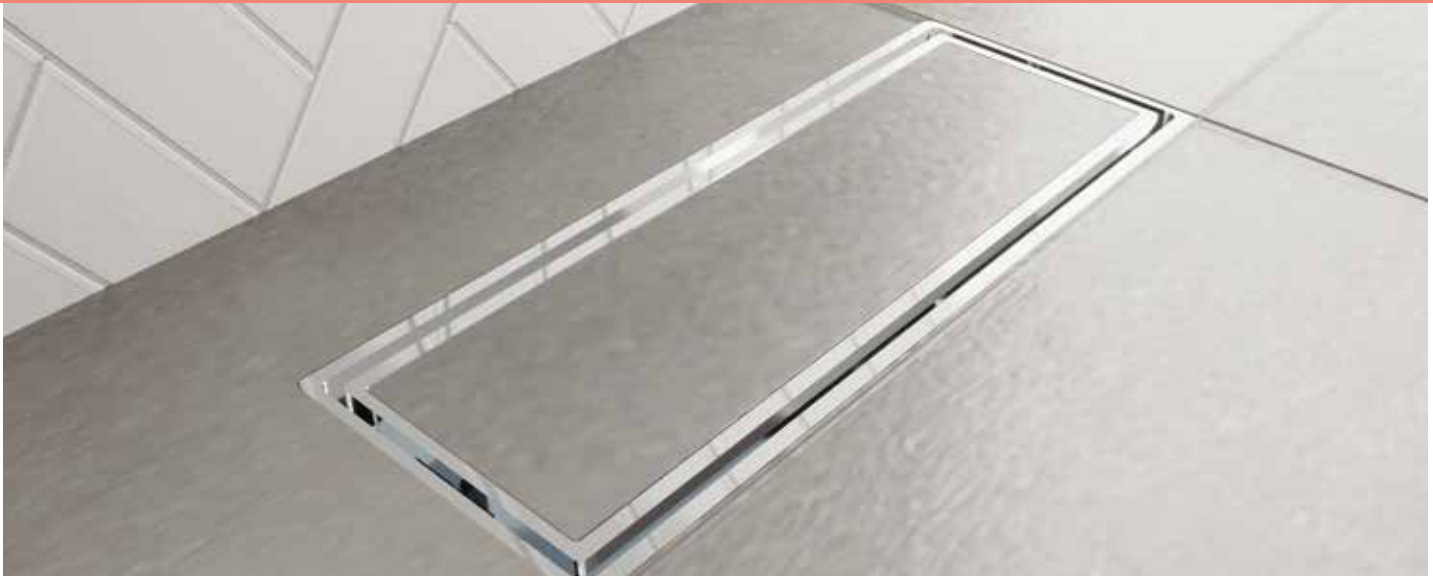

SA-021-L	Tubo portapapel armado laca	\$ 244.46
SA-021-S	Tubo portapapel armado satin	\$ 230.79
SA-080	Tubo portapapel antirrobo armado cromo	\$ 431.84
SA-119	Taq. plast-6 ancla y pija 10-16 x 1"	\$ 43.45
SA-120	Taq. plomo-3 y pija 10-16-AB x 2"	\$ 90.05
SA-124	Taquete plomo -3 y pija 10-16	\$ 61.90
SA-125	Paquete de pijas c/ taquetes barra seg.	\$ 117.17
SA-172	Paquete de pijas con taquetes	\$ 55.03
SA-223	Juego de taquetes con pijas 10-16x1"	\$ 14.23
SA-225	Soporte c/chap. izquierdo Nuva cromo	\$ 1,089.88

 SA-255	Dosificador para jabonera cromo	\$ 669.53
--	---------------------------------	-----------

SA-255-S	Dosificador para jabonera satin	\$ 770.05
----------	---------------------------------	-----------

# COLADERAS







Modelo	Descripción	Precio	Modelo	Descripción	Precio
RC-002	Anillo para coladera 444 y 444X	\$ 139.99	 RC-020	Rejilla contra coladera 24, 25, 26, 342	\$ 149.42
RC-003	Tornillo colad. 444, 446, 4954 y 2514	\$ 4.88			
RC-006	Anillo para coladera 446X	\$ 405.50			
RC-008	Canasta para base coladera 5424	\$ 608.62	 RC-024	Casquillo para coladera 27 y 28	\$ 105.47
RC-009	Rejilla canasta coladera 5424	\$ 264.35			
RC-010	Contra rejilla coladera 262	\$ 925.61			
 RC-011	Rejilla de contra 262-H, 282-H, 1342-H	\$ 322.94	RC-026	Campana base coladera 2514, 2584	\$ 503.03
			RC-027	Rejilla coladera 2514	\$ 376.78
 RC-012	Tornillo niquelado No. 10	\$ 4.88	RC-028	Rondana de presión 3/8"	\$ 1.26
			RC-030	Rejilla rectangular 2714	\$ 876.45
 RC-014	Contra rejilla cuadrada	\$ 1,722.57	 RC-032	Casquillo contra chica 24	\$ 63.71
 RC-016	Casquillo contra grande 282-H	\$ 144.64	 RC-033	Tapa ciega coladera 26	\$ 147.51
 RC-018	Tapa ciega coladera 282-H, 1342-H	\$ 222.91	RC-034	Campana para coladera 2714	\$ 503.03
			 RC-037	Rej. cuad. 1342, 282 acero inoxidable	\$ 347.13
 RC-019	Contra rejilla coladera 24, 25, 26, 342	\$ 578.56	RC-042	Marco angular base 4954	\$ 326.22
			RC-043	Rejilla para coladera 4954	\$ 297.56
			RC-048	Rejilla coladera 2584 20 x 20	\$ 1,410.36



# COLADERAS

Modelo	Descripción	Precio
 RC-054	Tornillo cab. plana No. 8-32 UNC x3-8"	\$ 4.88
 RC-062	Rejilla contra coladera 632-H	\$ 721.81
RC-066	Empaque tapa exterior válvula 1176	\$ 72.36
RC-068	Brazo tapa interior válvula 1176	\$ 339.58
RC-069	Columpio válvula 1176	\$ 123.39
RC-072	Tapa interior válvula 1176	\$ 1,137.84
 RC-073	Cúpula de coladera 444 y 444-X	\$ 461.49
RC-074	Rejilla cuadrada ciega	\$ 332.24
 RC-078	Cúpula de coladera 446-X	\$ 978.67
 RC-098	Contra rejilla cuadrada 24, 25-CH y 24-CH	\$ 737.90
 RC-100	Rejilla cuadrada 24-25-CH Ac. Inox.	\$ 149.42
RC-103	Contra coladera Red 24HL y 25HL	\$ 289.19
 RC-104	Cúpula p/contra coladera lisa chica	\$ 372.45
RC-105	Inserto p/coladera redonda lisa chica	\$ 159.09
 RC-106	Casquillo chico p/coladera lisa redonda	\$ 43.96

Modelo	Descripción	Precio
RC-110	Cúpula p/contra coladera cuad. gde. lisa	\$ 502.59
RC-111	Casquillo grande para coladera lisa	\$ 41.67
RC-112	Inserto para coladera grande	\$ 353.90
RC-115	Llave para coladera lisa	\$ 31.85
RC-134	Tapa ciega cuadrada coladera 24 y 25-CH	\$ 156.41
RC-142	Contra redonda chica 25-HLI	\$ 458.01
RC-143	Cúpula redonda chica 24 y 25-HLI	\$ 332.69
RC-148	Cúpula p/rebosadero lisa red y cuad/chic	\$ 353.82
RC-154	Llave p/mantenimiento 24 y 25-HLI	\$ 85.77
RC-161	Contra coladera perimetral Chica	\$ 453.73
 RC-162	Porta inserto cuadrado chico	\$ 423.88
RC-164	Contra coladera perimetral GDE	\$ 1,129.58
SC-002	Marco y soporte soldado col. 2584	\$ 1,646.07
 SC-007	Rejilla con campana armada	\$ 887.13
SC-008	Kit para coladera 2584	\$ 3,086.21
 SC-011	Rejilla col. 282-1342 c/ casquillo	\$ 1,463.57
SC-012	Rej. ciega c/casquillo p/coladera 282-1342	\$ 1,323.83
 SC-016	Rejilla para coladera 24 y 25 c/casquillo	\$ 834.62
SC-020	Rej. ciega para coladera 26 c/casquillo	\$ 832.80
 SC-021	Contra armada redonda lisa chica	\$ 949.63
SC-022	Contra armada cuadrada lisa chica	\$ 1,214.24
SC-023	Contra armada redonda lisa grande	\$ 1,870.71
SC-024	Rejilla para coladera 27 y 28 con casquillo	\$ 886.33
SC-025	Contra armada cuadrada lisa grande	\$ 1,665.49
SC-028	Rejilla a. Inox. c/casq. p/coladera 1342-35 CH	\$ 2,232.23
SC-035	Rejilla p coladera cuadrada con casquillo	\$ 874.42

# COLADERAS

Modelo	Descripción	Precio	Modelo	Descripción	Precio
 <b>SC-036</b>	Contra armada p/coladera 24-HLI	\$ 993.76			
<b>SC-037</b>	Contra arm. redonda p/coladera 282-HLI	\$ 1,870.71			
 <b>SC-040</b>	Contra arm. cuad. p/coladera 24 y 25-CHLI	\$ 1,043.90			
<b>SC-041</b>	Ctra. arm. cuad. p/coladera 1342 y 282 CHLI	\$ 2,289.33			
<b>SC-042</b>	Porta inserto cuadro chico c/tornillo	\$ 581.03			
<b>SC-043</b>	Porta inserto cuadro gde. c/tornillo	\$ 1,044.87			
 <b>SC-049</b>	Contra armada para coladera 24-RHLI	\$ 3,417.14			
<b>SC-055</b>	Porta inserto Rect c/ tornillo soporte	\$ 1,725.60			
<b>SC-057</b>	Porta inserto 24-RHLI	\$ 1,196.66			
<b>SC-063</b>	Rejilla redonda PE-18-41 342CL	\$ 233.54			
 <b>SC-064</b>	Contra armada para coladera 24-RHLI-60	\$ 4,112.56			
<b>SC-066</b>	Contra armada para coladera 24-RHLI-90	\$ 7,674.42			

# VÁLVULAS Y VARIOS



Modelo	Descripción	Precio	Modelo	Descripción	Precio
RV-008	O'ring 2-214	\$ 6.47	 RV-215	O'ring 2-109	\$ 2.58
RV-056	O'ring 2-015	\$ 3.32	RV-225	Opresor allen 5/32"	\$ 14.02
 RV-071	Rondana para espárrago hule	\$ 12.82	 RV-249	Rejilla salida de tina Elite	\$ 36.66
RV-072	Rondana para espárrago latón	\$ 21.98	 RV-259	Sello para llave economizadora	\$ 17.35
RV-086	O'ring 2-124	\$ 9.69	RV-262	Separador boquilla para economizadora	\$ 7.76
 RV-089	Rondana hule tapón céspol	\$ 7.16	 RV-263	Filtro llave economizadora	\$ 12.26
RV-090	Tapón céspol lavabo	\$ 102.42	 RV-268	Empaque para boquilla economizadora	\$ 5.09
RV-091	Tuerca cuerpo y codo céspol	\$ 252.62	RV-279	Barril protector economizadora	\$ 45.10
RV-092	Codo para céspol lavabo	\$ 527.25			
 RV-093	O'ring 2-218	\$ 16.81			
RV-094	Chapetón para céspol lavabo	\$ 131.46			
RV-105	Tuerca hexagonal 3/4-14	\$ 70.34			
RV-126	Tornillo 3/8" cabeza plana ranurada -16 UN	\$ 12.26			
 RV-130	Resorte cónico economizadora	\$ 12.26			
RV-163	O'ring 2-008	\$ 2.58			

# VÁLVULAS Y VARIOS

Modelo	Descripción	Precio
 <b>RV-280</b>	Boquilla economizadora	\$ 108.95
<b>RV-283</b>	Empaque neopreno economizadora	\$ 13.99
<b>RV-284</b>	Seguro barril economizadora	\$ 2.58
<b>RV-331</b>	O'ring 2-013	\$ 5.09
<b>RV-386</b>	Espárrago salida Alfa II	\$ 76.72
<b>RV-399</b>	Tornillo m-4 x 29/64"	\$ 4.63
<b>RV-401</b>	Porta cartucho mon. para regadera	\$ 292.87
<b>RV-431</b>	Llave allen 5/64"	\$ 17.72
<b>RV-456</b>	Llave allen 332	\$ 29.84
<b>RV-551</b>	Filtro p/valv check p/sal	\$ 52.06
<b>RV-554</b>	Vastago valv push	\$ 36.51
<b>RV-618</b>	Tuerca espaciadora	\$ 54.89
 <b>RV-660</b>	Pila de litio CR-P2 6V para fluxómetros y llaves	\$ 301.41
 <b>RV-668</b>	Espárrago salida electrónica	\$ 157.30
 <b>RV-713</b>	Rondana acero inoxidable	\$ 5.22
<b>RV-727</b>	Tornillo 10-2A-UNC-2A Cr	\$ 19.99
<b>RV-727-S</b>	Tornillo 10-2A-UNC-2A satin	\$ 22.01
 <b>RV-729</b>	Casquillo para cartucho	\$ 32.50
<b>RV-732</b>	Extensión maneral monomando Cr	\$ 178.67
<b>RV-732-S</b>	Extensión maneral monomando satin	\$ 223.30
<b>RV-733</b>	Buje para maneral monomando Cr	\$ 119.34
<b>RV-733-S</b>	Buje para maneral monomando satin	\$ 149.25
<b>RV-740</b>	O'ring 2-028	\$ 7.34
<b>RV-742</b>	Llave allen 2 mm	\$ 20.71
<b>RV-760</b>	Tapón Saltina Elite	\$ 173.30
<b>RV-763</b>	O'ring 2-023	\$ 11.73
<b>RV-774</b>	Tubo trampa céspol TV-017 Cr	\$ 181.66
<b>RV-776</b>	Empaque sello tubo céspol TV-017	\$ 8.72
<b>RV-777</b>	Tapa de servicio céspol Nuva Cr	\$ 379.25
<b>RV-778</b>	Chapetón tubo desagüe Cr	\$ 204.32
<b>RV-779</b>	Tubo desagüe para céspol Cr	\$ 534.98
<b>RV-780</b>	Porta sensor para salidas electrónicas	\$ 41.30
<b>RV-782</b>	Filtro para electroválvula	\$ 33.96

Modelo	Descripción	Precio
<b>RV-788</b>	Cable toma corriente	\$ 114.64
<b>RV-792</b>	O'ring 2-030	\$ 14.93
<b>RV-796</b>	Base de electroválvula para clip	\$ 87.14
<b>RV-798</b>	Empaque base para salida	\$ 21.94
<b>RV-810</b>	Empaque sello tapa céspol	\$ 22.41
<b>RV-825</b>	Resorte de compresión push	\$ 22.62
<b>RV-827</b>	Empaque para TV-120	\$ 12.32
<b>RV-828</b>	Inserto central válvula de push	\$ 11.92
<b>RV-829</b>	Vaso de válvula push	\$ 44.89
<b>RV-830</b>	Vastago central para push	\$ 8.82
<b>RV-833</b>	O'Ring 6-685	\$ 9.50
<b>RV-834</b>	Empaque cónico inferior para TV-120	\$ 11.83
<b>RV-835</b>	Resorte cónico para cartucho TV-120	\$ 47.42
<b>RV-838</b>	Arillo regulador p/cartucho TV-120-Cr	\$ 154.25
<b>RV-841</b>	Separador cuerpo central de Sahaoprene	\$ 51.75
<b>RV-844</b>	Rondana para céspol TV-017	\$ 13.11
<b>RV-855</b>	Empaque para salida electrónica	\$ 25.09
<b>RV-865</b>	O'ring 2-130	\$ 11.46
<b>RV-886</b>	Reductor de Velicidad p/ IG-40	\$ 1,121.75
<b>RV-937</b>	Rompe chorros salida de tina	\$ 18.98
<b>RV-952</b>	Conector p/salida de tina a pared 3/4"	\$ 235.86
<b>RV-961</b>	Opresor allen Al 1/4" 20x 5/8"	\$ 9.38
<b>RV-1027</b>	O'ring 2-202	\$ 6.41
<b>RV-1225</b>	Sello de perfil blando para IG-20	\$ 398.68
 <b>RV-1255</b>	Tornillo p/IG-20 de 1/2" " -13 UNC ALL	\$ 57.13
<b>RV-1277</b>	Empaque Cónico para push	\$ 12.21
<b>RV-1283</b>	O'ring 2-222	\$ 8.83
<b>RV-1300</b>	Inserto para mon. regadera plástico	\$ 3.83
<b>RV-1306</b>	Botón desviador p/mon. reg. Cr	\$ 158.03
<b>RV-1306-S</b>	Botón desviador p/mon. reg. satin	\$ 181.73
<b>RV-1315</b>	Tubo extensión p/tarja doble	\$ 157.86
<b>RV-1320</b>	Empaque para céspol tarja	\$ 15.39
<b>RV-1350</b>	Botón cuadrado p/desviador mon. reg. Cr	\$ 378.91
<b>RV-1350-S</b>	Botón cuadrado p/desv. mon. reg. satin	\$ 435.77
<b>RV-1404</b>	Empaque p/chapetón mon. reg. Magna	\$ 7.66
<b>RV-1407</b>	Buje antifricción p/mon. reg. Nuva	\$ 6.32
<b>RV-1409</b>	Buje antifricción p/ monomando Cr.	\$ 3.20
<b>RV-1445</b>	Soporte p/sensor sal. elec. lav. TV-200 Nuva	\$ 114.67
<b>RV-1446</b>	Chapetón para sensor TV-200 Cr	\$ 319.29
<b>RV-1469</b>	Portacartucho p/monom. reg. Vértika	\$ 301.33
<b>RV-1471</b>	Esfera manija monom. reg E-700 Vértika	\$ 86.01
<b>RV-1471-S</b>	Esfera manija monom. reg E-700 Vértika-S	\$ 98.90
<b>RV-1472</b>	Chapetón redondo p/mom reg. E-700 Vértika Cr	\$ 178.41
<b>RV-1472-S</b>	Chapetón red. p/mon reg. E-700 Vértika-S	\$ 205.18
<b>RV-1473</b>	Rondana antifricción p/chapetón redondo	\$ 17.25
<b>RV-1474</b>	Tuerca port. cart.mon.reg. Vértika-Premier	\$ 104.90
<b>RV-1476</b>	Manija p/monom. reg. E-700 Vértika CR.	\$ 447.16

# VÁLVULAS Y VARIOS

Modelo	Descripción	Precio
RV-1476-S	Manija p/mon. reg. E-700 Vértika-S	\$ 513.73
RV-1479	Tuerca sup. p/mon. reg. Vértika-Premier	\$ 153.61
RV-1480	SopORTE p/chapeton mon reg E-700 Vértika	\$ 88.71
RV-1486	Llave p/tuerca cartucho mon. reg. Vértika	\$ 47.95
RV-1555	Inserto p/salidas lavabo electrónica	\$ 125.21
RV-1558	Palanca p/monomando reg. tina Premier Cr	\$ 486.98
RV-1558-S	Palanca p/mon. reg. tina Premier S	\$ 560.02
RV-1573	Tuerca espárrago p/salida capacitiva	\$ 53.48
RV-1576	Espárrago salida capacitiva TV-190	\$ 52.39
RV-1578	Espárrago de sujeción para salida	\$ 76.43
RV-1616	Conector para Valvex Check	\$ 86.98
RV-1622	Sello de perfil blando IG-20 PTM	\$ 398.68
RV-1662	Base llave economizadora a pared	\$ 236.64
RV-1663	Tuerca portafiltro	\$ 101.41
RV-1664	Vástago porta filtro	\$ 218.10
RV-1682	Opresor 8-32 UNC 2A X 0.18	\$ 8.78
RV-1691	Empaque amortiguador p/mon. regadera	\$ 12.44
RV-1701	Niple salida economizadora	\$ 165.91

 **RV-1809** Codo p/cespol de 40 cm p/TV-016 \$ 484.04

**RV-1917** Empaque sello para cartucho BP \$ 47.27

 **RV-1966** Pila alcalina AA p/salidas electrónicas \$ 32.14

**SV-006** Cuerpo central con niple \$ 326.51

**SV-052** Mang. flex B4F20" \$ 227.13

**SV-062** Palanca y perilla economiz. Cr \$ 103.80

Kit para salida economizadora \$ 332.12

**SV-064**

- RA-345** Resorte de compresión
- RV-130** Resorte cónico
- RV-259** Sello lat. sal. e.
- RV-262** Separador sal. e.
- RV-263** Filtro sal. econom.
- RV-268** Emp. boq. sal. e.
- RV-279** Barril protec. sal. e.
- RV-280** Boquilla 7/8 sal. e.
- RV-284** Seguro p/barril e.
- SV-062** Palanca y perilla llave econom.

**SV-071** Cubre tornillos con sello Cr \$ 239.22

 **SV-072** Chapeton con sello adhesivo Cr \$ 602.65

Modelo	Descripción	Precio
SV-191	Paquete pijas taquetes	\$ 28.27
SV-239	Chapeton con sello adhesivo 8" Cr	\$ 1,079.58
SV-262-K	Kit Cartucho monomando 40 mm BP	\$ 1,225.62
SV-290	Paq. de torno p/chapeton mon. de reg.	\$ 31.56
SV-290-N	Paquete tornillos p/chapeton mon. reg. N	\$ 31.45
SV-290-S	Paquete tornillos p/chapeton mon. reg. S	\$ 36.18
SV-305	Válvula para desviador monomando	\$ 1,033.06
SV-305-S	Válvula p/desviador monomando satin	\$ 1,137.01
SV-326	Chapeton para monom. E-762 Cr	\$ 1,252.67
SV-329	Juego de tornillos M5 X 0.8 Cr	\$ 81.01
SV-329-S	Juego de tornillos M5X0.8 S	\$ 93.18

 **SV-335** Maneral mon. reg. Nuva armado Cr \$ 1,348.53

**SV-336** Chapeton oval c/ empaque Cr \$ 1,212.98

**SV-336-S** Chapeton oval c/ empaque satin \$ 1,334.30

**SV-337** Chap. mon. Nuva E-47, E-771 c/emp. Cr \$ 911.63

**SV-337-S** Chap. mon. Nuva E-47, E-771 satin c/emp. \$ 1,002.82

**SV-339** Chap.c/empaque mon. reg. Nuva PVD Cr \$ 1,212.98

**SV-339-S** Chapeton oval c/empaque c/desviador satin \$ 1,334.39

**SV-348** Cartucho economizador cierre \$ 837.20

automático TV-120 Cr

**SV-348-S** Cartucho economizador cierre automático \$ 921.28

TV-120 Satin

 **SV-358** Sensor para lavamanos \$ 2,714.48

C1016 LM

 **SV-359** Electroválvula \$ 1,194.06

6V-1/2" nueva

 **SV-360** Fuente de alimentación \$ 2,340.98

115-230 Vac 6VDC



# VÁLVULAS Y VARIOS

Modelo	Descripción	Precio
SV-361	Manguera de 1/2"-1/4" 12 Longitud	\$ 181.26
 SV-362	Porta pilas nuevo	\$ 556.25
 SV-365	Cartucho para monomando regadera	\$ 722.27
SV-371	Chapetón para monomando	\$ 1,252.67
SV-382	Mampara soldada 2 p/interceptor IG-40	\$ 1,265.57
SV-383	Mampara soldada 3 p/interceptor IG-40	\$ 1,081.50
SV-386	Tapa con cerradura para IG-40	\$ 7,513.27
SV-390	Mampara soldada chica interc. IG-20	\$ 361.63
SV-391	Mampara soldada grande interc. IG-20	\$ 516.59
SV-392	Placa desviadora soldada interc. IG-20	\$ 462.90
SV-395	Tapa para caja interceptor de grasa	\$ 6,022.49
 SV-409	Cartucho monomando 40 mm BP	\$ 1,205.23
 SV-409-S	Cartucho monomando 40 mm BP	\$ 1,205.23
SV-421	Espárrago conector arm. p/salida de tina	\$ 948.24
SV-444	Canasta c/agarradera para IG-40	\$ 2,681.12
SV-446	Canasta c/agarradera para IG-20	\$ 1,775.07
SV-452	Maneral monom. Kúbica p/ 35 mm Cr	\$ 1,452.16
 SV-454	Economizador para TV-105	\$ 93.91
SV-486	Tapa interceptora de grasa IG-20	\$ 3,375.52
 SV-487	Manguera Flexible de 1/2" NPSM 12"	\$ 210.31

Modelo	Descripción	Precio
 SV-492	Módulo electrónico capacitivo	\$ 4,725.58
 SV-504	Válvula check p/salida econ. push TV-120	\$ 243.12
 SV-515	Sensor p/lav. a pared longitud 120 cm	\$ 3,304.85
SV-517	Maneral para monomando Kúbica II CR	\$ 1,452.16
SV-517-S	Maneral para monomando Kúbica II satín	\$ 1,669.96
 SV-520	Desviador armado para mon. regadera CR	\$ 816.35
SV-520-S	Desviador arm. p/ mon. d/regad. S	\$ 907.09
 SV-521	Kit reparación c/empaques p/ desv. cpo. reg.	\$ 22.10
SV-531	Chapetón con empaque p/mon. reg. Vértika	\$ 942.47
SV-531-S	Chap. con empaque p/mon. reg. Vértika satín	\$ 1,083.82
 SV-539	Maneral armado p/mon. reg. Explora Cr	\$ 977.62
SV-540	Cartucho p/salida tina Innovex	\$ 455.87
SV-541	Desviador arm. p/mon. reg botón cuad.	\$ 1,415.08
 SV-542	Chapetón con empaque p/mon. reg. Explora Cr	\$ 554.67
SV-546	Chapetón con empaq. mon. reg. c/desv. Explor	\$ 571.18
SV-551	Aireador tipo srpay 0.5 GPM	\$ 171.58
SV-554	Chapetón c/empaque p/mon. regadera desv.	\$ 1,307.45
SV-554-S	Chapetón c/empaque p/mon. regadera desv.	\$ 1,503.57















# VÁLVULAS Y VARIOS

Modelo	Descripción	Precio
 SV-558	Maneral armado para monomando reg. Novus CR	\$ 691.41
 SV-559	Maneral armado para monomando reg. Aqua Cr	\$ 967.92
SV-559-S	Maneral armado p/mon. reg. Aqua satín	\$ 1,113.11
SV-560	Maneral armado p/mon. reg. Magna Cr	\$ 1,158.50
SV-561	Maneral armado p/mon. lavabo Nuva Cr	\$ 655.06
SV-561-S	Maneral armado p/mon. lavabo Nuva Satín	\$ 753.33
SV-567	Chapetón c/empq. p/mon. reg. E-702 Premier Cr	\$ 579.41
SV-567-S	Chapetón c/ empques p/mon. regadera S.	\$ 637.34
 SV-575	Desv. armado p/mon. reg. botón cuad. Cr	\$ 1,360.17
SV-577	Chapetón c/empques p/monom. de lav.	\$ 579.41
SV-590	Aireador oculto HC STD m24x1	\$ 92.70
SV-593	Válvula check p/salida econ push	\$ 709.22
 SV-604	Aireador spray oculto 0.5 GPM.	\$ 226.39
 SV-605	Aireador spray oculto 0.5 GPM. m 24x1	\$ 226.39
SV-612	Chapetón armado p/mon. de regadera	\$ 208.09
 SV-632	Vástago válvula push con O'ring	\$ 90.40
 SV-633	Kit de empques para válvula push	\$ 71.42



















Modelo	Descripción	Precio
 SV-645	Cartucho 40 mm mon. Barreno pasado	\$ 862.29
SV-651	Maneral redondo para regadera	\$ 538.03
SV-653	Maneral cuadrado mon/reg E-710	\$ 571.82
SV-660	Aumento p/porta cartucho VBP mon. sol	\$ 21.94
SV-685	Desviador para mon. de reg. cromo	\$ 888.84
SV-686	Boton desviador PIU 201 Cr	\$ 398.27
SV-687	Kit de empques p/desviador mon. reg.	\$ 70.15
SV-688	Porta cartucho c/O'ring 40mm. mon. reg.	\$ 371.36
SV-688-S	Porta cartucho c/O'ring 40mm. mon. reg. S.	\$ 427.07
SV-689	Kit boton válvula temporizadora de reg.	\$ 890.87
SV-696	Paquete de sujeción salida push TV-120	\$ 86.57
SV-726	Chapeton armado monomando E-713	\$ 719.32
 SV-731	Porta pilas p/salidas electrónicas	\$ 336.96
SV-754	Chapeton tapa armado mon. E-713	\$ 178.62
SV-755	Maneral maxima 40 mm E-713	\$ 836.08
SV-756	Kit de llaves de mantenimiento E-713	\$ 144.70
SV-757	Chapeton tapa armado mon. E-712	\$ 227.80
SV-758	Maneral maxima 40 mm. E-712	\$ 836.08
SV-759	Kit de llaves de mantenimiento E-712	\$ 144.70
SV-765	Chapeton s/barr portacartucho Gde. E781	\$ 1,584.30
SV-766	Caja armada para componentes electrónico	\$ 248.33
 SV-790	Cartucho KX D 40 mm	\$ 451.14
 SV-798	Cartucho de 35 mm	\$ 471.97
 SV-806	Cartucho de 35 mm	\$ 493.58

# FLUXÓMETROS



Modelo	Descripción	Precio	Modelo	Descripción	Precio
 RF-003	Émbolo hembra para fluxómetro	\$ 261.26	 RF-030	Resorte estopero para fluxómetro	\$ 18.43
 RF-005	Rondana hule émbolo hembra para fluxómetro	\$ 14.84	 RF-032-C	Tuerca unión cople cuerpo principal cromo	\$ 147.82
 RF-015	Tornillo No. 8-32 UNC x 1/2	\$ 3.53	RF-033	Rondana fibra NPL-EXT	\$ 11.79
 RF-016	Rondana neopreno cúpula fluxómetro	\$ 11.26	 RF-035	O'ring 2-123	\$ 8.89
 RF-018	O'ring 2-028	\$ 7.34	 RF-036	Anillo presión NPL-EXT	\$ 26.00
 RF-024	Rondana hule para manija fluxómetro	\$ 23.23	 RF-037-C	Tuerca unión cople llave de retención cromo	\$ 151.37
 RF-025	Empaque cónico para estopero de fluxómetro	\$ 22.43	 RF-038-C	Cuerpo llave retención 1" P Flux Cr	\$ 692.42
			 RF-040	Guía delrin émbolo para fluxómetro	\$ 31.45

# FLUXÓMETROS

Modelo	Descripción	Precio	Modelo	Descripción	Precio
RF-041	Tornillo elevador llave retención s/cr	\$ 34.48	 RF-060	Rondana polietileno tuerca spud de 38 mm	\$ 5.97
 RF-041-C	Tornillo elevador p/ llave de retención cromo	\$ 45.10	RF-062	Tuerca spud 38 mm sin cromar	\$ 100.41
RF-042	Tuerca superior llave	\$ 138.92	 RF-062-C	Tuerca spud 38 mm cromo	\$ 160.39
 RF-042-C	Tuerca superior llave cromo	\$ 166.90	 RF-063	Tuerca F2-32 mm cromo	\$ 161.40
 RF-044	Rondana hule para tuerca F-2 de 32 mm	\$ 13.63	RF-068	Niple recto de 38x60 cromo	\$ 562.95
 RF-045	Rondana polietileno de 32 mm	\$ 7.16	 RF-070	Codo latón de 32 mm para flux. cromo	\$ 472.75
RF-047	Niple recto 32 mm p/flux. WC	\$ 122.36	 RF-072	Codo latón de 38 mm para flux. cromo	\$ 579.54
 RF-047-C	Niple recto 32 mm cromo p/flux. WC	\$ 203.07	 RF-075	Rondana S-21 vulcanizada	\$ 67.09
 RF-048	Tuerca spud 32 mm	\$ 163.30	RF-076	Codo latón p/spud 38 mm 60 mm p/flux Cr	\$ 967.96
 RF-049	Rondana polietileno tuerca spud de 32 mm	\$ 5.97	 RF-080	Tuerca spud de 19 mm cromo	\$ 111.07
 RF-050	Rondana hule tuerca spud 32 mm y 38 mm	\$ 12.50	 RF-081	Rondana tuerca spud de 19 mm	\$ 11.26
 RF-052	Goma llantita S-14 vulcanizada	\$ 111.74	RF-096	Codo de latón de 19 x 90 fluxómetro	\$ 360.48
 RF-059-C	Niple recto de 38 mm cromo p/fluxómetro de WC Cr	\$ 255.92	 RF-104	Porta pedal fluxómetro	\$ 485.20





# FLUXÓMETROS

Modelo	Descripción	Precio	Modelo	Descripción	Precio
 RF-105	Pedal para fluxómetro	\$ 255.39	 RF-247	Chapetón grande spud 32 mm cromo	\$ 165.65
 RF-106	Prisionero para pedal fluxómetro	\$ 22.56	RF-248	Chapetón chico de 32 mm llave reten. Cr	\$ 161.40
 RF-107	Botón para fluxómetro	\$ 113.94	 RF-249	Chapetón chico de 19 mm mingitorio	\$ 163.30
RF-108	Niple extensión para fluxómetro cromo	\$ 237.54	 RF-250	Émbolo llave retención	\$ 36.82
 RF-109	Tuerca cople para fluxómetro 6 lts.	\$ 144.86	 RF-256	Inserto émbolo llave de retención para fluxómetro	\$ 41.53
RF-110	Cuerpo llave retención p/fluxómetro	\$ 901.88	 RF-278	Chapetón spud 38 mm	\$ 165.11
RF-111	Codo latón de 32 mm fluxóm. de pedal	\$ 502.99	 RF-292	Manija recta para fluxómetro	\$ 202.56
RF-112	Niple de 32 mm fluxóm. pedal p/WC	\$ 521.00	RF-294	Rondana de latón 3 lts	\$ 129.51
RF-118	Base pedal fluxómetro	\$ 659.09	 RF-295	Rondana de latón 6 lts	\$ 129.51
 RF-120	O'ring 2-006 para perno estopero	\$ 4.32	RF-300	Perno asiento flux.pilas y corriente Nk	\$ 100.83
RF-124	Niple p/cuerno tall piece fluxómetro	\$ 267.14	 RF-309	Émbolo macho delrin 6 lts	\$ 75.69
 RF-223	O'ring 2-110	\$ 2.97	RF-325	Émbolo macho fluxómetro 3 lts.	\$ 69.41
 RF-230	Cuerpo estopero con cuerda fluxómetro	\$ 137.20	RF-336	Cpo. estopero fluxómetro electrónico Nk	\$ 165.65
 RF-232	Émbolo hembra 6 lts. electrónico	\$ 298.51	 RF-338	Resorte perno fluxómetro electrónico	\$ 5.37
RF-233	Émbolo hembra 3 lts. p/flux electrónicos	\$ 303.98	RF-339	Tuerca perno fluxómetro electrónico	\$ 64.81
 RF-234	Resorte émbolo llave retención	\$ 11.26	RF-340	Arandela goma llantita	\$ 10.06





# FLUXÓMETROS

Modelo	Descripción	Precio
 RF-341	Goma llantita fluxómetro electrónico	\$ 16.43
 RF-344	O'ring 2-025	\$ 4.74
 RF-494	Filtro para fluxómetro de pila	\$ 147.01
RF-496	Cople externo con alojamiento	\$ 213.92
 RF-497	Cople int. p/ flux. bat NK	\$ 250.37
RF-519	Resorte de compresión p/botón de flux.	\$ 10.56
RF-521	Botón manual p/flux. electrónico Cr	\$ 169.33
 RF-523	Perno para fluxómetro	\$ 67.44
RF-525	Tornillo Allen 5-40 x 1/4"	\$ 45.05
RF-530	O'ring 2-116	\$ 9.54
RF-532	Tornillo para carcasa	\$ 48.00
RF-546	Botón para llave de retención	\$ 27.62
RF-547	Tubo camisa para fluxómetros de 5"	\$ 256.93
RF-550	Caja p/ circuito eléctrico de fluxómetro	\$ 233.21
RF-551	Tapa circuito electrónico sin sensor	\$ 263.13
RF-552	Tornillo 8-32 x 1 1/4"	\$ 7.12
 RF-554	Porta electroválvula	\$ 645.12
RF-555	Porta sensor	\$ 13.36
RF-560	Llave plana para fluxómetros	\$ 77.13
RF-569	Cúpula llave de retención	\$ 296.25
RF-570	Cúpula p/flux Nuva Cr	\$ 513.04
RF-576	Inserto base fluxómetro	\$ 376.84
RF-583	Tuerca base	\$ 367.37
RF-584	Tuerca base fluxómetro	\$ 427.81
RF-586	Tuerca unión flux. spud 38	\$ 407.66
RF-590	Tuerca spud 32 mm p/fluxómetro 410-32	\$ 243.46
RF-591	Rondana para cúpula fluxómetro	\$ 44.56

Modelo	Descripción	Precio
RF-614	Chapetón para fluxómetros cromo	\$ 92.43
RF-616	O'ring 2-132	\$ 5.71
RF-617	O'ring 2-122	\$ 4.48
RF-619	O'ring 2-20	\$ 3.09
RF-623	Manija recta para fluómetro 210	\$ 403.09
RF-630	Empaque sello fluxómetro	\$ 12.32
RF-631	Tuerca unión cople para cuerpo principal	\$ 181.91
RF-634	Tuerca unión fluxómetro	\$ 306.24
RF-636	Adaptador Budnik	\$ 251.53
 RF-637	Empaque p/llave de retención	\$ 20.56
RF-662	Tapón p/fluxómetro de doble botón Cr	\$ 251.92
RF-671	Tuerca para botón flux	\$ 214.21
RF-672	Botón fluxómetro electrónico Cr	\$ 169.33
 RF-673	Resorte para botón flux	\$ 23.41
 RF-674	Empaque estopero flux	\$ 23.42
RF-675	Estopero para botón flux	\$ 137.20
RF-680	Rondana delrin p/mingitorio	\$ 4.95
RF-693	Émbolo macho del RIN 4.8 LPF	\$ 75.69
RF-694	Rondana bushing 4.8 LPF	\$ 99.24
RF-699	Émbolo macho 0.5 LPF	\$ 75.69
RF-700	Rondana para mingitorio 1.5 L	\$ 45.24
RF-718	Rondana bushing 0.5 LPF	\$ 99.24
 RF-757	Empaque p/tuerca spud 19 ming.	\$ 6.41
RF-788	Rondana bushing 1 LPF	\$ 99.24
RF-789	Émbolo macho del RIN 1 LPF	\$ 75.69
RF-812	Niple para flux de pedal 7.3" Long	\$ 454.62
RF-813	Chapetón 42mm p/flux de pedal	\$ 161.40
RF-873	Perno émbolo /autolimpieza /WC-ming.	\$ 55.60
RF-874	Rondana bushing embolo de autolimpieza	\$ 129.51
RF-923	Perno émbolo de autolimpieza de ming.	\$ 151.15
RF-924	Rondana bushing emb de autlimpieza 4.8 L	\$ 123.04
 RF-941	Rondana de hule spud de 38 mm	\$ 16.41









# FLUXÓMETROS

Modelo	Descripción	Precio
 RF-983	Casquillo estopero para flux.	\$ 68.72
RF-999-C	Niple recto 32 mm. x 40cm. long Cr	\$ 240.41
RF-1005	Rondana bushing embolo autolimpieza 3.5L	\$ 123.04
RF-1070	Botón para SF-586	\$ 169.33
 SF-002	Asiento con perno émbolo fluxómetro 6 lt	\$ 124.76
 SF-008-C	Llave retención armada cromada	\$ 1,049.89
SF-009	Niple recto reducción 32-19 p/mingitorio	\$ 220.38
 SF-012	Perno con asiento estopero O'ring para fluxómetro 6 L	\$ 73.11
SF-014	Llave de retención RECT FLUX	\$ 1,228.57
SF-015	Mecanismo cierre llave de retención s/c	\$ 167.91
SF-015-C	Mecanismo cierre llave de retención	\$ 191.21
 SF-024	Emb. arm. p/fluxómetro regular	\$ 700.85
SF-039	Niple recto reducción 32-19 fluxómetro	\$ 234.51
SF-054	Kit émbolo fluxómetro	\$ 259.53
 RF-005	Rond. hule émb.hembra p/flux.	
RF-015	Torn. No.8-32 NC x 1/2	
RF-016	Rond. neop. cúpula flux.	
RF-052	Llantita S-14 vulcanizada	
RF-075	Rondana S-21 vulcanizada	
SF-055	Kit llave de retención	\$ 111.07
 RF-637	Empaque p/llave de retención flux	
RF-035	O'ring 2-123	
RF-234	Res. émbolo llave ret.	
RF-256	Asiento p/émbolo	
RH-337	O'ring 2-114	







Modelo	Descripción	Precio
SF-056	Kit Manija y pedal	\$ 74.22
 RF-024	Rond. p/manija flux.	
RF-025	Emp. cónico p/estopero	
RF-030	Resorte estopero	
RF-120	O'ring 2-006 p/perno estopero	
SF-057	Kit rondanas spud de 19 mm	\$ 47.08
 RF-044	Rond. hule tuerca F-2 D 32 mm	
RF-081	Rond. fibra tca. 19	
RF-757	Empaque p/tca. spud 19 ming.	
SF-058	Kit rondanas spud de 32 mm	\$ 49.86
 RF-044	Rond. hule p/tca. F-2 de 32 mm	
RF-045	Rond. fibra p/tca. de 32 mm	
RF-049	Rond. fibra tca. spud 32 mm	
RF-050	Rond. hule tca. spud 32-38 mm	
SF-059	Kit rondanas spud de 38 mm	\$ 41.53
 RF-060	Rond. fibra tca. spud 32-38 mm	
RF-941	Rond. hule spud 38 mm	
SF-063	Tuerca F-2 de 32 mm	\$ 182.34
SF-064	Rondana y tuerca spud 32 mm	\$ 181.15
 SF-070	Rondana y tuerca spud 38 mm	\$ 178.83
SF-077	Rondana y tuerca spud 19 mm	\$ 166.90
SF-100	Émbolo armado fluxómetro 3 lts	\$ 688.43
SF-102	Asiento c/perno emb p/flux. 3L	\$ 128.23
 SF-106	Manija armada para fluxómetro cromo	\$ 497.30
 SF-110	Estopero armado con cuerda fluxómetro	\$ 261.32
 SF-113	Portapedal armado 3 y 6 lts	\$ 837.11

# FLUXÓMETROS

Modelo	Descripción	Precio
SF-124	Émbolo armado fluxómetro 6 lts	\$ 700.85
SF-147	Niple muro fluxómetro de pedal	\$ 1,430.51
SF-157	Perno arm. niquelado para flux. electr.	\$ 189.74
		
SF-164	Cople interno con perno armado	\$ 569.87
SF-170	Émbolo armado flux. electrónico 6 lts	\$ 752.27
SF-171	Émbolo armado flux. electrónico 3 lts	\$ 752.27
SF-177	Cople interior con perno armado	\$ 601.05
		
SF-179	Cople ext. arm. cuerda izq. p/flux. Bat.	\$ 745.13
SF-200	Kit fluxómetro de manija 6 lts	\$ 2,178.11
SF-201	Kit fluxómetro de manija 3 lts	\$ 2,178.11
SF-202	Kit fluxómetro de pedal 6 lts	\$ 2,716.37
SF-203	Kit fluxómetro de pedal 3 lts	\$ 2,716.37
SF-555	Sensor p/fluxómetro corriente CI019/1000	\$ 2,714.48
		
SF-556	Sensor p/fluxómetro d/bat	\$ 2,714.48
		
SF-557	Dispositivo actuador elec. flux bat.	\$ 9,902.86
SF-571	Llave de retención armada	\$ 1,225.35
		
SF-572	Llave de retención armada ped.	\$ 1,486.06
		
SF-586	Botón accionador mecánico fluxómetro nuevo	\$ 644.35
		









Modelo	Descripción	Precio
SF-588	Portapedal armado para flux. 3 y 6 L	\$ 1,467.84
SF-589	Botón accionador mec. p/flux. electr.	\$ 492.10
SF-590	Asiento c/perno émbolo 4.8 LPF	\$ 128.23
SF-591	Émbolo ecológico armado 4.8	\$ 697.83
SF-599	Asiento c/perno émbolo 0.5 LPF	\$ 128.23
SF-600	Émbolo ecológico armado 0.5 L	\$ 666.86
SF-621	Cúpula para fluxómetro con empaque Nuva Cr.	\$ 564.66
		
SF-628	Manija recta armada p/flux. Nuva Cr	\$ 743.69
		
SF-651	Émbolo armado 1 lts	\$ 636.36
SF-665	Tuerca adaptación 32 mm c/empaques	\$ 262.01
		
SF-719	Émbolo Flux. 6 LPF autolimpieza	\$ 651.95
		
SF-741	Émbolo Flux. 4.8 LPF autolimpieza	\$ 649.15
		
SF-743	Émbolo Flux. 1 LPF autolimpieza	\$ 591.96
		
SF-744	Émbolo Flux. 0.5 LPF autolimpieza	\$ 620.33
		
SF-760	Kit de empaques para carcasa	\$ 196.03
		
SF-761	Kit de empaques para botón Nota: Para modelo anterior botón SF-914	\$ 93.35
		

# FLUXÓMETROS

Modelo	Descripción	Precio	Modelo	Descripción	Precio
 SF-763	Anillo de seguridad para fluxómetro	\$ 833.98			
SF-764	Portapila flexible p/flux. electrónico	\$ 373.45			
SF-765	Émbolo flux. 1.9 LPF	\$ 556.90			
 SF-774	Émbolo Flux. 3 LPF autolimpieza	\$ 640.39			
 SF-781	Cúpula arm. para flux. de autolimpieza	\$ 818.62			
 SF-782	Asiento con perno m. flux. 6 L autolimpieza	\$ 128.23			
SF-783	Asiento c perno emb flux 4.8 L autolimpieza	\$ 128.23			
 SF-799	Boton de seguridad p/fluxometros	\$ 38.69			
 SF-804	Émbolo Flux. 3.5 LPF autolimpieza	\$ 640.39			
 SF-805	Dispositivo electrónico para Flux. de batería	\$ 7,395.68			
SF-926	Perno con inserto p/ botón SF-586	\$ 122.43			
SF-930	Kit mtto preventivo botón actual SF-586	\$ 74.22			

# REGADERAS



Modelo	Descripción	Precio	Modelo	Descripción	Precio
 <b>RR-003</b>	Empaque de vinil para nudo regadera	\$ 9.02	<b>RR-028</b>	Plato regadera H-500 CR	\$ 121.63
<b>RR-005</b>	Émbolo delrin AC-50	\$ 25.25	<b>RR-032</b>	Rondana hule regadera H-100	\$ 55.67
<b>RR-009</b>	Emblema regadera H-1000	\$ 14.28	<b>RR-038</b>	Opresor 1/8"-40 UNC	\$ 6.40
 <b>RR-010</b>	Disco guía delrin AC-50	\$ 44.63	 <b>RR-040</b>	Empaque hule H-600	\$ 33.71
 <b>RR-011</b>	Emblema Helvex AC-50	\$ 16.85	<b>RR-041</b>	Plato regadera H-600 Cr	\$ 157.63
<b>RR-012</b>	Tornillo moleteado émbolo p/reg. cromo	\$ 68.54	<b>RR-042</b>	Tornillo para plato H-600 Cr	\$ 29.17
<b>RR-013</b>	Tuerca para cuerpo campana cromo	\$ 316.66	<b>RR-044</b>	Empaque regadera manual Futura	\$ 7.22
<b>RR-014</b>	Nudo manzana grande AC-10 cromo	\$ 303.18	 <b>RR-047</b>	Empaque vinil nudo H-600	\$ 4.48
<b>RR-016</b>	Mariposa para nudo de reg./ cromo	\$ 184.88	<b>RR-054</b>	O'ring 2-227	\$ 16.85
<b>RR-018</b>	Rondana hule base mural	\$ 21.40	<b>RR-071</b>	Tuerca para cuerpo reg. AC-110	\$ 425.56
<b>RR-019</b>	Tapa cuadrada delrin AC-20 cromo	\$ 45.50	<b>RR-073</b>	Opresor No. 8-32 UNC	\$ 14.02
 <b>RR-023</b>	O'ring 2-024	\$ 5.87	 <b>RR-076</b>	Niple de muro regadera manual RM3 Cr	\$ 173.22
<b>RR-025</b>	Tornillo 3 regadera H-500	\$ 39.32	<b>RR-076-S</b>	Niple de muro regadera manual RM3 S	\$ 208.12
<b>RR-027</b>	Empaque hule regadera H-500	\$ 40.14	 <b>RR-081</b>	O'ring 2-010	\$ 3.32



# REGADERAS

Modelo	Descripción	Precio
 RR-082	O'ring 2-113	\$ 4.48
 RR-085	Rondana latón vulcanizada	\$ 69.17
RR-086	Émbolo para sello regadera man. RM-3 N	\$ 20.69
RR-100	Seguro terminal manguera flexible p/reg. mon. RM3	\$ 8.14
RR-105	Tornillo 10-24 UNC-2A x 1/2"	\$ 3.32
RR-106	Opresor Aller 8-32 UNC 24/1/8"	\$ 20.73
RR-107	Opresor Allen 8-32 UNC-2A x 1/4"	\$ 7.23
 RR-116	Empaque para manguera flexible p/regadera man. RM-3	\$ 6.77
RR-123	Tuerca unión para nudo H-500	\$ 32.98
RR-134	Plato para reg. H-2000 Cr	\$ 87.24
RR-135	Emblema H-2000	\$ 12.27
RR-139	O'ring 2-211	\$ 5.10
RR-142	Tuerca unión nueva	\$ 52.88
 RR-144	Anillo plástico para regadera H-200	\$ 38.20
 RR-162	Rondana neopreno para nudo	\$ 18.61
RR-195	Niple para regadera manual	\$ 15.97
RR-198	O'ring 2-037	\$ 22.01
RR-201	Brazo para regadera econ. H-200 cromo	\$ 328.31
RR-202	Chapetón para brazo regadera cromo	\$ 206.34
RR-202-S	Chapetón para brazo regadera satín	\$ 226.92
RR-204	Empaque hule plato regadera H-400	\$ 14.28
RR-207	Chapetón maneral Óptima cromo	\$ 154.14
RR-211	Nudo regadera H-400 Antiqua cromo	\$ 160.28
RR-212	Plato regadera H-400 Antiqua cromo	\$ 244.95
RR-212-S	Plato regadera H-400 Antiqua satín	\$ 269.39
RR-220	Soporte regadera manual Futura cromo	\$ 479.51
 RR-249	Inserto para tuerca regadera Antiqua	\$ 15.59

Modelo	Descripción	Precio
RR-250	Inserto para tuerca regadera cromo	\$ 17.96
RR-254	Arillo base para regadera	\$ 56.53
RR-258	Plato p/regadera H-2000 cromo	\$ 106.66
RR-259	O'ring 2-212	\$ 5.09
RR-264	Plato regadera H-300 cromo	\$ 180.30
RR-265	Empaque para plato regadera	\$ 38.07
RR-273	Tornillo phillips 10-24 X 21/4"	\$ 44.47
RR-284	Tuerca cuerpo regadera H-900 Nuva cromo	\$ 166.15
RR-290	Plato para regadera H-900 Nuva cromo	\$ 158.37
RR-290-S	Plato para regadera H-900 Nuva satín	\$ 174.23
RR-291	O'ring 2-026 p/salidas de lavabo	\$ 3.83
RR-294	O'ring 2-128	\$ 11.02
RR-296-S	Cuerpo para regadera H-900 Nuva S	\$ 425.05
RR-298	Conector para regadera cromo	\$ 199.97
RR-301	Plato p/regadera H-100 cromo	\$ 341.74
RR-307	Cuerpo interior regadera H-900 Nuva	\$ 321.96
RR-310	Empaque interior p/base de regadera	\$ 18.51
RR-311	Tornillo para plato regadera H-3000 Cr	\$ 82.96
RR-319	O'ring 2-177	\$ 165.91
RR-320	Empaque para boquilla de regadera	\$ 13.72
RR-321	Empaque para tornillo regadera	\$ 2.39
RR-322	Empaque para regadera H-3000	\$ 6.25
RR-323	O'ring 2-157	\$ 87.10
 RR-337	Chapetón para brazo regadera cromo	\$ 239.42
RR-338	Antical individual para regadera	\$ 6.45
RR-341	Filtro para regadera	\$ 89.05
RR-350	Conector Miura cromo	\$ 273.77
RR-363	Tornillo 1/4"-20 x 0.350"	\$ 69.16
RR-364	Chapetón cuadrado regadera Kúbica Cr	\$ 294.92
RR-364-S	Chapetón cuadrado reg. Kúbica satín	\$ 324.53
RR-387	Conector p/brazo de regadera Kúbica Cr	\$ 303.44
RR-393	Conector para regadera Kúbica cromo	\$ 243.89
RR-410	Tuerca para regadera Premier	\$ 74.72
RR-431	Tapón p/soporte de sujeción de regadera Cr	\$ 73.78
RR-433	Barra de sujeción p/reg. deslizable Cr	\$ 847.76
RR-439	Casquillo de desviador de regadera Nuva Cr	\$ 479.32
RR-442	Tapón guía p/casquillo desviador	\$ 32.17
RR-496	Tapete anticalcáreo p/reg. Premier	\$ 331.42
RR-497	Difusor para regadera premier TR	\$ 147.51
RR-499	Empaque para regadera	\$ 19.13
RR-501	Soporte de regadera Nuva manual Cr	\$ 439.90
RR-514	Tapete con anticalcareos reg Kúbica	\$ 375.61
RR-552	Empaque para regadera Vértika	\$ 43.18
RR-554	Nudo para regadera Cr	\$ 475.38
RR-555	Chapetón para regadera Vértika cromo	\$ 351.89
RR-574	Tuerca hexagonal p/nudo regadera H-201	\$ 74.27

# REGADERAS

Modelo	Descripción	Precio
RR-586	Empaque p/codo regadera ducha	\$ 22.32
RR-601	Chapetón cuadrado p/brazo reg. Kúbica Cr	\$ 477.79
RR-604	Tapete antical d/reg kubica 6"	\$ 347.63
RR-610	Tapete anticalcáreo para regadera H-201	\$ 354.37
RR-612	Plato para regadera H-201 cromo	\$ 165.02
RR-613	Difusor para regadera H-201 Explora	\$ 117.08
RR-620	O'ring 2-042	\$ 19.60
RR-622	Botón de sujeción p/regadera Kúbica Cr	\$ 74.15
RR-667	Cpo. Distribuidor d/reg.H900 Nuva	\$ 42.05



**RR-704** Tapete anticalcáreo para regadera \$ 366.73

RR-705	Plato regadera doble	\$ 64.64
RR-710	Difusor para regadera	\$ 9.41
RR-733	Tapete anticalcáreo regadera Vértika	\$ 394.54
RR-740	Opresor Allen 5-40 UNC X 1/4"	\$ 6.40
SR-004	Cpo. reg. RM-3 c/tubos Cr	\$ 1,565.52
SR-005-L	Manguera armada regadera RM-3 L	\$ 1,621.78



**SR-005** Manguera armada regadera RM-3 cromo \$ 474.68

**SR-005-S** Manguera armada regadera RM-3 S \$ 1,193.65



**SR-013** Émbolo armado regaderas AC \$ 199.62

**SR-026** Varilla armada para desviador p/RM-3 Cr \$ 352.90



**SR-027** Cabezal p/reg. manual Futura cromo \$ 355.44

**SR-044** Nudo armado p/regadera H-400 cromo \$ 261.20  
**SR-044-S** Nudo armado regadera H-400 Antiqua S \$ 300.36



**SR-080** Economizadora para regaderas 10 lts x min \$ 93.90

Modelo	Descripción	Precio
SR-086	Chapetón para brazo regadera cromo	\$ 156.22

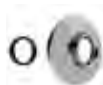

**SR-086-S** Chapetón para brazo regadera satin \$ 171.85  
**SR-095** Nudo arm. p/reg. H-800 Elegance Cr \$ 417.32



**SR-101** Conector regadera Celta RM-21 \$ 272.07

SR-101-S	Conector regadera Celta RM-21 satin	\$ 299.25
SR-103	Chapetón p/ reg. c/ancla Elegance Cr	\$ 456.78
SR-104	Perilla armada para regadera	\$ 169.07
SR-124	Pija	\$ 47.98
SR-137	Manguera 1/2" x 1/4" NPSM 15" L Cr	\$ 247.95
SR-142	Varilla armada p/reg. manual RM-12 Cr	\$ 1,189.03
SR-142-S	Varilla armada p/reg. manual RM-12-S	\$ 1,275.61



**SR-143** Soporte armado p/reg. manual RM-12 Cr \$ 790.57

SR-143-S	Soporte armado p/reg. manual RM-12-S	\$ 909.16
SR-156	Varilla armada p/reg. manual RM-13 Cr	\$ 1,170.45
SR-157	Soporte arm. reg. man. Vértika RM-13 Cr	\$ 1,291.47
SR-157-SD	Soporte arm. reg. man. Vértika RM-13-SD	\$ 1,549.73
SR-158	Juego de soportes p/reg. manual RM 26 Cr	\$ 859.76

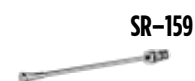



**SR-159** Varilla armada p/regadera manual Cr \$ 1,157.65

SR-159-S	Varilla armada p/regad. manual satin	\$ 1,331.33
SR-160	Chapetón c/soporte p/reg. manual Cr	\$ 1,205.81
SR-161	Cuerpo con varilla arm p/eg. manual Cr	\$ 2,723.17
SR-162	Ancla chapetón c/soporte Cr	\$ 980.49
SR-175	Chapetón con O'ring p/brazo de reg. Gde.	\$ 243.86
SR-176	Cpo c/varilla arm. p/reg RM-17	\$ 2,335.18
SR-177	Kit empaques p/varilla RM	\$ 50.62









**SR-173** Cpo c/varilla arm para regadera RM-14 \$ 2,765.79



# REGADERAS

Modelo	Descripción	Precio	Modelo	Descripción	Precio
 SR-186	Cabezal para regadera Antiqua Cr	\$1,637.42			
SR-186-S	Cabezal para regadera Antiqua Satín	\$1,883.04			
SR-195	Tapón con O'ring para barra spt de reg cr	\$71.63			
SR-211	Cabezal para regadera RM-12-H101	\$1,265.93			
SR-211-S	Cabezal para regadera RM-12-H101-S	\$1,392.52			
 SB-1009	Kit 5 pzas. economizador reg. 8.3 Lts. X min.	\$680.63			
 SB-1010	Kit 5 pzas. economizador reg. 5.6 Lts. X min.	\$680.63			

# ESPECIALES



Modelo	Descripción	Precio
SB-328	Valv check p/MBP arm.	\$ 234.67
 RB-851	Llave inglesa 9"	\$ 487.23
RB-852	Estuche para herramienta Helvex	\$ 527.32
RB-853	Llave niquelada para dosificador	\$ 72.26
 SB-804	Manguera p/reg. manual RM-20 y RM-21	\$ 474.68
SB-804-S	Manguera p/reg. RM-20 y RM-21 satin	\$ 1,193.65
SB-903	Cabezal p/regadera RM-23	\$ 2,400.65
SB-904	Cabezal p/regadera RM-26	\$ 2,313.59
 SB-905	Cabezal p/regadera RM-25	\$ 1,289.72
 SB-912	Soporte deslizable de regadera	\$ 1,359.94
 SB-985	Cabezal p/monomando de cocina E-305	\$ 2,477.57
 SB-987	Cabezal para regadera manual RM-28	\$ 777.93
 SB-988	Cabezal cinco chorros Reg. man. RM-29	\$ 1,433.34

Modelo	Descripción	Precio
SB-1016	Economizador p/regadera 6L	\$ 93.90
 SB-1029	Cabezal p/regadera manual Nuva	\$ 837.16
SB-1029-S	Cabezal p/regadera manual Nuva satin	\$ 963.30
SB-1038	Kit tornillo taquete llave p/secador d/manos	\$ 118.73
SB-1060	Sensor para jabonera líquida MB-1011	\$ 2,415.20
 SB-1061	Kit llave cerradura dosificadora	\$ 301.90
SB-1062	Deposito dispensador de jab. MB-1100	\$ 120.76
SB-1064	Carbón p/secador de manos MB-1012	\$ 187.03
SB-1108	Valv. dosificadora de espuma p/MB-1101	\$ 602.03
SB-1109	Sensor p/dosificador de espuma MB-1101	\$ 2,079.65
SB-1110	Cabezal reg. manual 5 chorros RMB-30	\$ 1,533.86
SB-1110-S	Cabezal reg. manual 5 chorros RMB-30-S	\$ 1,763.06
 SB-1111	Reg. manual de 3 chorros	\$ 1,117.15
SB-1111-S	Reg. manual de tres chorros/satin	\$ 1,285.45
SB-1132	Cable de impulso para sin sarro S-25 Vul	\$ 825.44
SB-1133	Porta baterias para MB-1101	\$ 119.60
SB-1237	Valvula dosif jabón liq MB-1102-AIB	\$ 602.03
SB-1241	Valvula dosificadora jabón liq MB-1100	\$ 777.34
SB-1259	Dispositivo electrónico MB-1102-AIB	\$ 2,633.39

# CERÁMICOS

**Modelo Descripción Precio**

## REFACCIONES DE MINGITORIO



	<b>CE</b> Cartucho TDS para mingitorio MGS-E y MGO-E	<b>\$ 1,020.00</b>
<b>DE-CH</b>	Dispositivo TDS para reemplazo MGS o MGO	<b>\$ 1,096.50</b>
	<b>CE-CH</b> Cartucho TDS para reemplazo modelo DE-CH	<b>\$ 1,020.00</b>
<b>LLE</b>	Llave para cartuchos TDS	<b>\$ 86.01</b>
	<b>CE-2</b> Cartucho TDS2 para mingitorio seco	<b>\$ 1,479.00</b>
<b>DE-2</b>	Cartucho TDS2 mingitorio seco Gobi Negev	<b>\$ 1,601.00</b>
<b>SX-RF-736</b>	Empaque para spud de 19 mm	<b>\$ 45.50</b>
<b>SX-RF-750</b>	Empaque para brida de mingitorio	<b>\$ 5.25</b>
	<b>SX-RF-766</b> Tuerca para codo articulado mingitorio seco	<b>\$ 42.02</b>
	<b>SX-RF-767</b> Tuerca para dispositivo TDS	<b>\$ 50.78</b>
<b>SX-RF-772</b>	Tubo codo para mingitorio MGS-E y MGO-E	<b>\$ 129.82</b>
	<b>SX-RF-817</b> Conector para céspol	<b>\$ 14.02</b>
<b>SX-RF-933</b>	Conector para céspol TDS2	<b>\$ 33.54</b>
<b>SX-RF-1111</b>	Tubo para codo mingitorio TDS2	<b>\$ 66.79</b>
<b>SX-RF-1141</b>	Codo para desagüe TDS doble esfera	<b>\$ 51.06</b>
<b>SX-SF-626-AI</b>	Contra para mingitorio armada acero inoxidable	<b>\$ 388.55</b>
<b>SX-SF-645</b>	Brida para mingitorio refacción	<b>\$ 229.30</b>
<b>SX-SF-646</b>	Kit de fijación ancla, pijas y tornillos	<b>\$ 91.22</b>
<b>SX-SF-647</b>	Spud para mingitorio 19 mm	<b>\$ 136.52</b>
<b>SX-SF-702</b>	Kit de contra armado para mingitorio	<b>\$ 96.67</b>
<b>SX-SF-746</b>	Conjunto para instalación mingitorio seco	<b>\$ 341.10</b>
	<b>SX-SF-748</b> Conjunto para instalación de mingitorio cascada	<b>\$ 204.38</b>
<b>SX-SF-773</b>	Codo tuerca para desalojo mingitorio seco	<b>\$ 170.38</b>





**Modelo Descripción Precio**

<b>SX-SF-848</b>	Difusor para mingitorio MG Mojave	<b>\$ 997.58</b>
<b>SX-SF-851</b>	Contra armada MG Mojave	<b>\$ 813.67</b>
<b>SX-SF-856</b>	Kit tuercas y empaque para difusor MG Mojave	<b>\$ 197.44</b>
<b>SX-SF-857</b>	Kit tuerca / empaque para conexión mingitorio	<b>\$ 49.21</b>
<b>SX-SF-858</b>	Césped MG Mojave	<b>\$ 165.03</b>
<b>SX-SF-1050</b>	Kit de contra largo armado para mingitorio	<b>\$ 153.71</b>

## REFACCIONES DE WC

<b>SX-RF-737</b>	Esparrago de WC para fluxómetro spud 38 mm	<b>\$ 283.65</b>
<b>SX-RF-738</b>	Rondana de spud para taza de fluxómetro 38 mm	<b>\$ 24.85</b>
<b>SX-RF-739</b>	Empaque para spud de 38 mm	<b>\$ 68.25</b>
<b>SX-RF-740</b>	Tuerca plana de WC para fluxómetro spud 38 mm	<b>\$ 129.89</b>
<b>SX-RF-831</b>	Tapa para tanque TT1 y TT2 Drakar blanco	<b>\$ 273.44</b>
<b>SX-RF-831-M</b>	Tapa para tanque TT1 y TT2 Drakar marfil	<b>\$ 273.44</b>
<b>SX-RF-832</b>	Tapa para tanque TT1-2 y TT2-2 Ródano blanco	<b>\$ 452.96</b>
<b>SX-RF-832-M</b>	Tapa para tanque TT1-2 y TT2-2 Ródano marfil	<b>\$ 452.96</b>
<b>SX-RF-833</b>	Tapa para tanque TT1-3 y TT2-3 Bolmen blanco	<b>\$ 452.96</b>
<b>SX-RF-833-M</b>	Tapa para tanque TT1-3 y TT2-3 Bolmen marfil	<b>\$ 452.96</b>
<b>SX-RF-834</b>	Tapa para tanque TTP-2 Ródano	<b>\$ 452.96</b>
<b>SX-RF-834-M</b>	Tapa para tanque TTP-2 Ródano marfil	<b>\$ 452.96</b>
<b>SX-RF-835-M</b>	Tapa para tanque TTP-3 Bolmen marfil	<b>\$ 452.96</b>

	<b>SX-RF-840</b> Empaque esponjoso para WC	<b>\$ 48.33</b>
	<b>SX-RF-846</b> Filtro para válvula de admisión para WC	<b>\$ 3.49</b>
	<b>SX-RF-872</b> Tapa para tanque TTR Olimpia	<b>\$ 258.24</b>
<b>SX-RF-951</b>	Cuello flexible para sanitario 100 mm	<b>\$ 140.86</b>
<b>SX-RF-967</b>	Cople para taza suspendida 4 3/4"	<b>\$ 82.26</b>
<b>SX-RF-970</b>	Tubo PVC para cople 4 3/4"	<b>\$ 153.83</b>
<b>SX-RF-1003</b>	Empaque de silicón para válvula 2"	<b>\$ 17.12</b>
<b>SX-RF-1004</b>	Empaque de silicón para válvula 3"	<b>\$ 20.56</b>

	<b>SX-RF-1010</b> Empaque esponjoso para WC 3"	<b>\$ 49.66</b>
	<b>SX-RF-1020</b> Tapa para tanque Murano	<b>\$ 1,216.65</b>
	<b>SX-RF-1024</b> Tapa para tanque OP Rivoli Plus	<b>\$ 1,701.38</b>
	<b>SX-RF-1079</b> Tapa para tanque Miura	<b>\$ 581.15</b>



# CERÁMICOS

Modelo	Descripción	Precio
 <b>SX-RF-1080</b>	Tapa para tanque Option	\$ 299.55
 <b>SX-RF-1090</b>	Tapa para tanque OP Capri Plus	\$ 1,701.38
<b>SX-RF-1106</b>	Llave 7/16" para instalación taza Miura	\$ 253.70
 <b>SX-RF-1114</b>	Tapa para tanque Drakar16	\$ 273.44
<b>SX-RF-1158</b>	Tapa para tanque WC Austral de botón	\$ 276.71
<b>SX-RF-1159</b>	Tapa tanque WC Austral de palanca	\$ 216.54
<b>SX-SF-634</b>	Kit válvula para tanque calibrado 4.8 L TTI	\$ 577.25
<b>SX-SF-635</b>	Kit válvula para tanque calibrado 3 y 6 L TT2	\$ 577.25
 <b>SX-SF-636</b>	Botón para tapa tanque 4.8 L CR	\$ 132.58
 <b>SX-SF-637</b>	Botón para tapa tanque 3 y 6 L CR	\$ 132.58
<b>SX-SF-643</b>	Juego de cubre pijas WC blanco	\$ 47.25
<b>SX-SF-643-M</b>	Juego de cubre pijas WC marfil	\$ 52.50
 <b>SX-SF-648</b>	Spud para taza fluxómetro de 38 mm	\$ 402.57
 <b>SX-SF-691</b>	Kit para anclaje de WC blanco	\$ 107.72
<b>SX-SF-691-M</b>	Kit para anclaje de WC marfil	\$ 107.72
<b>SX-SF-699</b>	Kit de palanca para TTP	\$ 171.24
 <b>SX-SF-704</b>	Kit de tornillos para sujeción de tanque	\$ 107.72
<b>SX-SF-705</b>	Kit valv para tanque palanca Rodano	\$ 731.93
 <b>SX-SF-707</b>	Extensión válvula de admisión con o'ring	\$ 22.76
<b>SX-SF-708</b>	Kit válvula para tanque calibrado 4.8 L Rodano	\$ 577.25
<b>SX-SF-709</b>	Kit válvula para tanque doble descarga Rodano	\$ 577.25
<b>SX-SF-710</b>	Kit válvula para tanque calibrado 4.8 L Bolmen	\$ 577.25
<b>SX-SF-711</b>	Kit válvula para tanque doble descarga Bolmen	\$ 577.25
<b>SX-SF-717</b>	Kit válvula para tanque calibrado 3.8 L Olimpia	\$ 577.25
<b>SX-SF-734</b>	Kit de sujeción AT-1	\$ 114.62
<b>SX-SF-735</b>	Kit de sujeción AT-2	\$ 132.58

Modelo	Descripción	Precio
<b>SX-SF-745-B</b>	Juego de cubre pijas WC blanco	\$ 106.77
<b>SX-SF-771</b>	Kit de fijación taza trampa oculta	\$ 193.33
<b>SX-SF-785</b>	Kit de sujeción para asiento AT-4	\$ 324.53
<b>SX-SF-798</b>	Juego de tuercas y rondanas para taza suspendida	\$ 149.79
<b>SX-SF-812</b>	Kit de válvula para tanque Murano 3"	\$ 763.47
<b>SX-SF-815</b>	Kit de válvula de admisión y válvula de descarga 3"	\$ 577.25
<b>SX-SF-832</b>	Kit válvula para tanque calibrado 4.8 L 3" Miura	\$ 763.47
<b>SX-SF-833</b>	Kit válvula para tanque Option	\$ 763.47
 <b>SX-SF-839</b>	Asiento para OP Capri Plus	\$ 1,625.54
 <b>SX-SF-840</b>	Kit de sujeción para OP Capri Plus	\$ 244.28
<b>SX-SF-842</b>	Kit válvula para tanque OP Capri Plus	\$ 763.47
<b>SX-SF-861</b>	Kit válvula sapo 3"	\$ 175.83
<b>SX-SF-867</b>	Kit válvula tanque calib 4.8 L 3" Drakar 16	\$ 577.25
<b>SX-SF-882</b>	Kit válvula para tanque Austral de botón	\$ 577.25
<b>SX-SF-883</b>	Kit válvula tanque Austral de palanca	\$ 598.19
<b>SX-SF-884</b>	Palanca para WC Austral	\$ 164.40
<b>SX-SF-942</b>	Kit de válvula de descarga	\$ 645.21
<b>SB-1147</b>	Kit de sujeción asiento AF-2	\$ 157.44

## REFACCIONES DE LAVABO

<b>SX-RF-898</b>	Chapetón para lavabo CR	\$ 39.59
<b>SX-RF-1011</b>	Chapetón para lavabo Futura 1y 3	\$ 31.55
<b>SX-SF-794</b>	Kit de sujeción para lavabo Marcus	\$ 154.98

HOJAS DE  
REFACCIONES  
**CERÁMICAS**

REFACCIONES ORIGINALES

Refacciones Originales

**HELVEX**

M.R.

garantía de calidad

## MG GOBI TDS2



#	Modelo	Descripción
1	CE-2	Cartucho TDS2 para mingitorio seco
2	SX-SF-1050	Kit de contra largo armado para mingitorio
3	SX-SF-646	Kit de fijación ancla, pijas y tornillos
4	SX-RF-750	Empaque para brida de mingitorio
5	SX-RF-767	Tuerca para dispositivo TDS
6	SX-RF-1111	Tubo para codo mingitorio TDS2
7	SX-RF-766	Tuerca para codo articulado mingitorio seco
8	SX-RF-933	Conector para céspol TDS2
9	LLE	Llave para cartuchos TDS
10	SX-RF-1141	Codo para desague TDS doble esfera
11	SX-SF-946	Codo armado para contras TDS2

Para cualquier duda sobre refacciones cerámicas comunícate al Departamento Oficina de Refacciones

## MG NEGEV TDS2



#	Modelo	Descripción
1	CE-2	Cartucho TDS2 para mingitorio seco
2	SX-SF-1050	Kit de contra largo armado para mingitorio
3	SX-SF-646	Kit de fijación ancla, pijas y tornillos
4	SX-RF-750	Empaque para brida de mingitorio
5	SX-RF-767	Tuerca para dispositivo TDS
6	SX-RF-1111	Tubo para codo mingitorio TDS2
7	SX-RF-766	Tuerca para codo articulado mingitorio seco
8	SX-RF-933	Conector para céspol TDS2
9	LLE	Llave para cartuchos TDS
10	SX-RF-1141	Codo para desagüe TDS doble esfera
11	SX-SF-946	Codo armado para contras TDS2

Para cualquier duda sobre refacciones cerámicas comunícate al Departamento Oficina de Refacciones

## MG MOJAVE TDS2



#	Modelo	Descripción
1	CE-2	Cartucho TDS2 para mingitorio seco
2	SX-SF-1050	Kit de contra largo armado para mingitorio
3	SX-SF-646	Kit de fijación ancla, pijas y tornillos
4	SX-RF-750	Empaque para brida de mingitorio
5	SX-RF-767	Tuerca para dispositivo TDS
6	SX-RF-1111	Tubo para codo mingitorio TDS2
7	SX-RF-766	Tuerca para codo articulado mingitorio seco
8	SX-RF-933	Conector para céspol TDS2
9	LLE	Llave para cartuchos TDS
10	SX-RF-1141	Codo para desagüe TDS doble esfera
11	SX-SF-946	Codo armado para contras TDS2

Para cualquier duda sobre refacciones cerámicas comunícate al Departamento Oficina de Refacciones



# MINGITORIOS

## MG MOJAVE

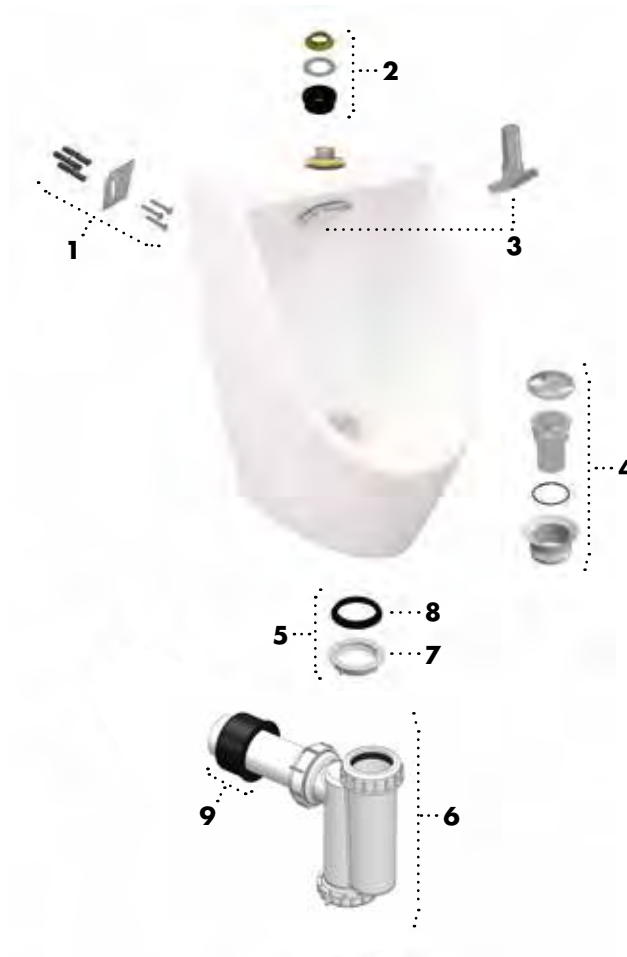

#	Modelo	Descripción
1	SX-SF-646	Kit de fijación ancla, pijas y tornillos
2	SX-SF-856	Kit tuercas y empaque para difusor MG Mojave
3	SX-SF-848	Difusor para mingitorio MG Mojave
4	SX-SF-851	Contra armada MG Mojave
5	SX-SF-857	Kit tuerca/empaque para conexión mingitorio
6	SX-SF-852	Césped MG Mojave
7	SX-RF-767	Tuerca para dispositivo TDS
8	SX-RF-750	Empaque para brida de mingitorio
9	SX-RF-933	Conector para céspol TDS2

Para cualquier duda sobre refacciones cerámicas comunícate al Departamento Oficina de Refacciones

## MG FERRY

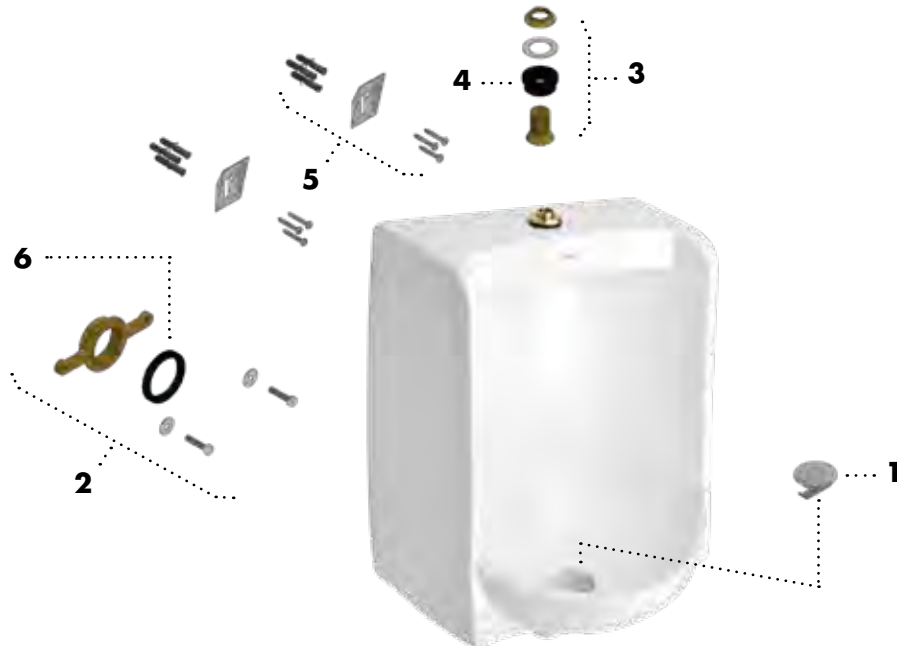

#	Modelo	Descripción
1	SX-SF-626-AI	Contra para mingitorio armada acero inoxidable
2	SX-SF-645	Brida para mingitorio
3	SX-SF-647	Spud para mingitorio 19 mm
4	SX-RF-736	Empaque para spud de 19 mm
5	SX-SF-748	Conjunto para instalación de mingitorio cascada
6	SX-RF-750	Empaque para brida de mingitorio

Para cualquier duda sobre refacciones cerámicas comunícate al Departamento Oficina de Refacciones

## BOLMEN16

4.8 LPD

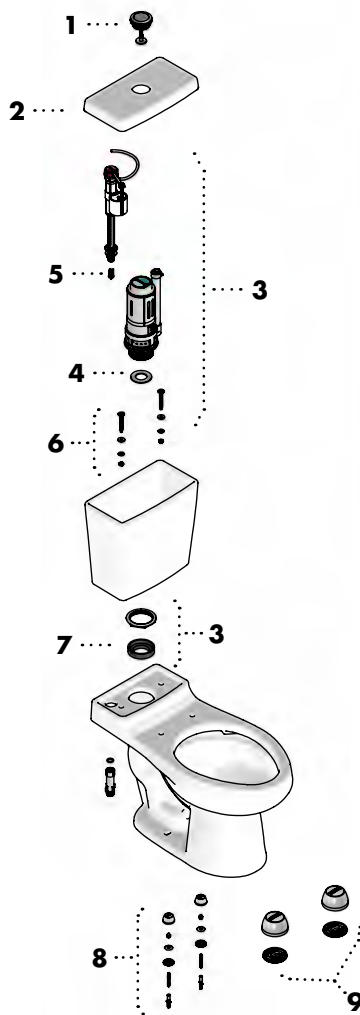

#	Modelo	Descripción
1	SX-SF-636	Botón para tapa tanque 4.8 L cromo
2	SX-RF-833	Tapa para tanque Bolmen16
3	SX-SF-942	Kit válvula para tanque calibrado 4.8 L TTI
4	SX-RF-1224	Empaque de silicón para válvula 3"
5	SX-RF-846	Filtro para válvula de admisión para WC
6	SX-SF-704	Kit de tornillos para sujeción de tanque
7	SX-RF-1010	Empaque esponjoso para WC
8	SX-SF-691 SX-SF-691-M (Marfil)	Kit para anclaje de WC blanco
9	SX-SF-643 SX-SF-643-M (Marfil)	Juego de cubre pijas WC blanco

Para cualquier duda sobre refacciones cerámicas comunícate al Departamento Oficina de Refacciones

## RÓDANO16 4.8 LPD

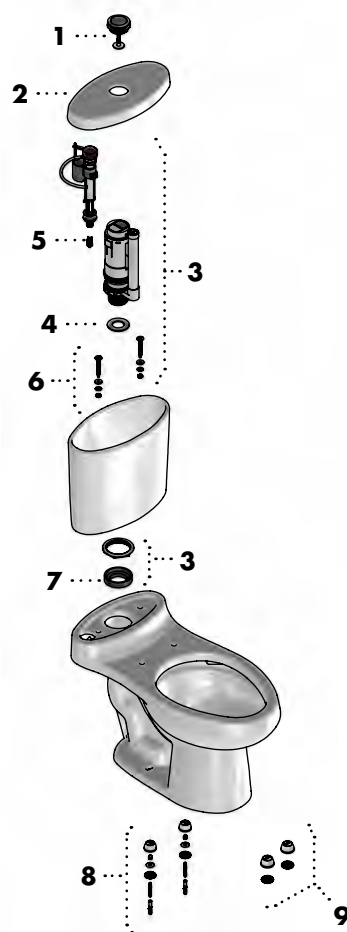

#	Modelo	Descripción
1	SX-SF-636	Botón para tapa tanque 4.8 L cromo
2	SX-RF-832	Tapa para tanque Rodano16
3	SX-SF-942	Kit válvula para tanque calibrado 4.8 L TTI
4	SX-RF-1224	Empaque de silicón para válvula 3"
5	SX-RF-846	Filtro para válvula de admisión para WC
6	SX-SF-704	Kit de tornillos para sujeción de tanque
7	SX-RF-1010	Empaque esponjoso para WC 2"
8	SX-SF-691 SX-SF-691-M (Marfil)	Kit para anclaje de WC blanco
9	SX-SF-643 SX-SF-643-M (Marfil)	Juego de cubre pijas WC blanco

Para cualquier duda sobre refacciones cerámicas comunícate al Departamento Oficina de Refacciones

## WC DRAKAR 4.8 LPD

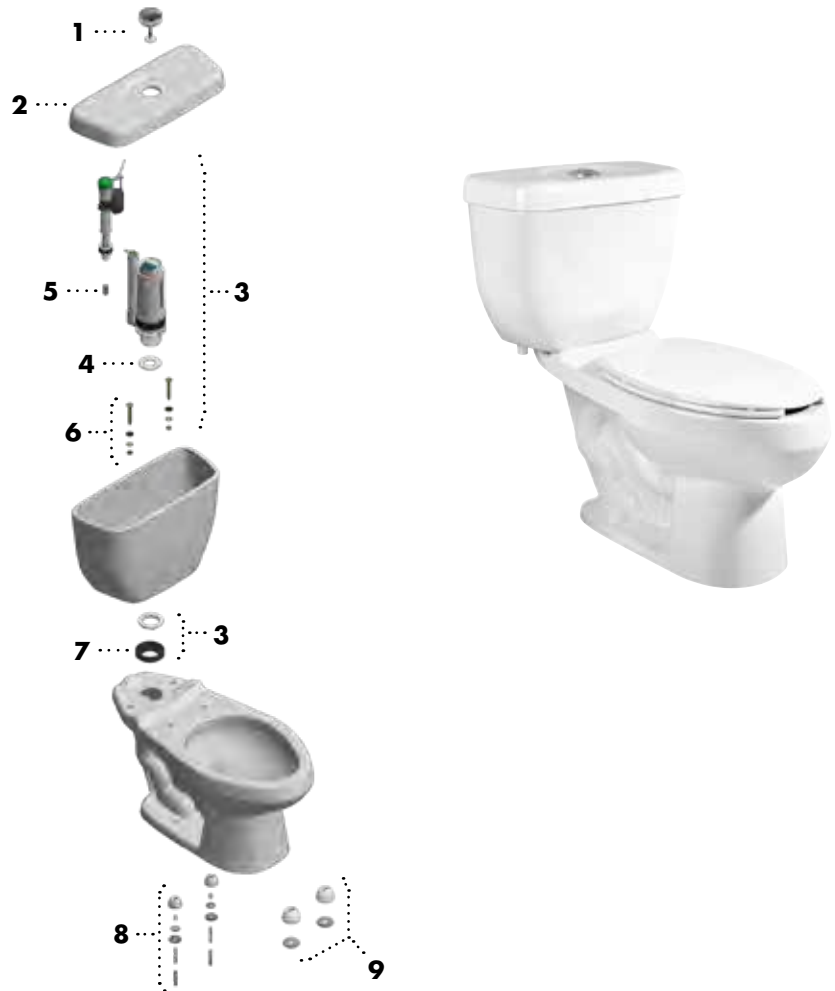

#	Modelo	Descripción
1	SX-SF-636	Botón para tapa tanque 4.8 L cromo
2	SX-RF-831	Tapa para tanque TT1 y TT2 Drakar blanco
3	SX-SF-634	Kit válvula para tanque calibrado 4.8 L TT1
4	SX-RF-1003	Empaque de silicón para válvula 2"
5	SX-RF-846	Filtro para válvula de admisión para WC
6	SX-SF-704	Kit de tornillos para sujeción de tanque
7	SX-RF-840	Empaque esponjoso para WC 2"
8	SX-SF-691 SX-SF-691-M (Marfil)	Kit para anclaje de WC blanco
9	SX-SF-643 SX-SF-643-M (Marfil)	Juego de cubre pijas WC blanco

Para cualquier duda sobre refacciones cerámicas comunícate al Departamento Oficina de Refacciones

## WC DRAKAR16 4.8 LPD

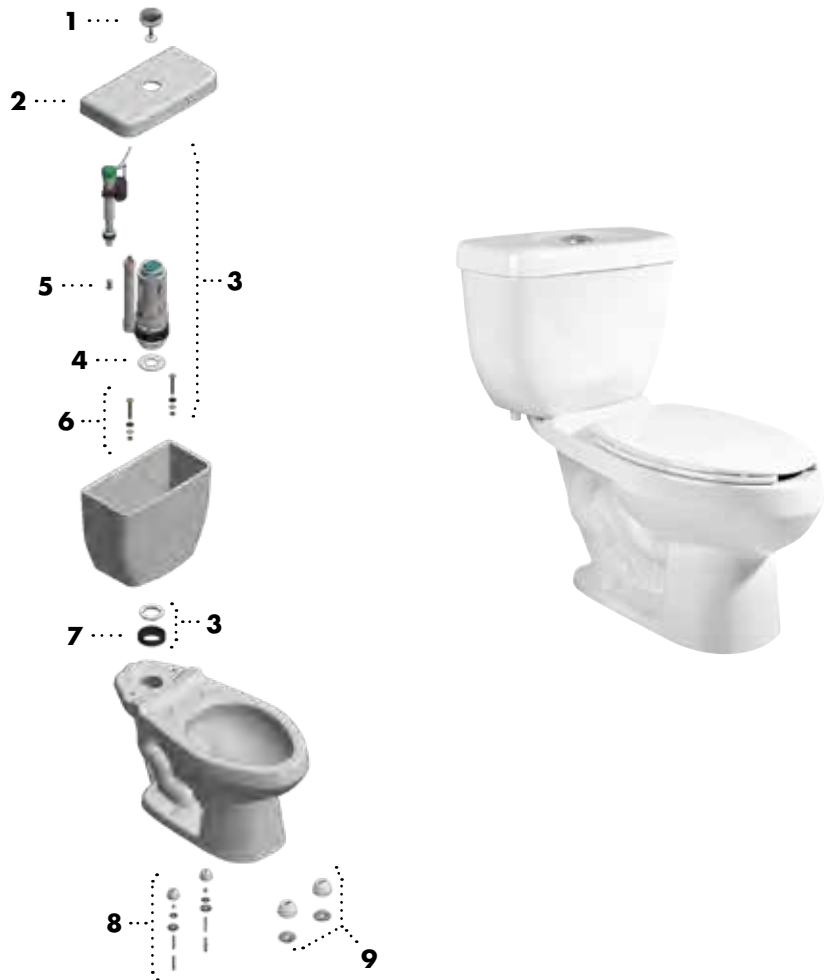

#	Modelo	Descripción
1	SX-SF-636	Botón para tapa tanque 4.8 L cromo
2	SX-RF-1114	Tapa para tanque Drakar 16
3	SX-SF-942	Kit válvula para tanque calibrado 3 y 6 L TT2
4	SX-RF-1224	Empaque de silicón para válvula 3"
5	SX-RF-846	Filtro para válvula de admisión para WC
6	SX-SF-704	Kit de tornillos para sujeción de tanque
7	SX-RF-1010	Empaque esponjoso para WC 3"
8	SX-SF-691 SX-SF-691-M (Marfil)	Kit para anclaje de WC blanco
9	SX-SF-643 SX-SF-643-M (Marfil)	Juego de cubre pijas WC blanco

Para cualquier duda sobre refacciones cerámicas comunícate al Departamento Oficina de Refacciones



## WC OLIMPIA 3.8 LPD



#	Modelo	Descripción
1	SX-SF-636	Botón para tapa tanque 4.8 L cromo
2	SX-RF-872	Tapa para tanque TTR Olimpia
3	SX-SF-942	Kit válvula para tanque calibrado 3.8 L Olimpia
4	SX-RF-846	Filtro para válvula de admisión para WC
5	SX-SF-704	Kit de tornillos para sujeción de tanque
6	SX-SF-707	Extensión válvula de admisión con o'ring
7	SX-RF-1224	Empaque de silicón para válvula 3"
8	SX-SF-691 SX-SF-691-M (Marfil)	Kit para anclaje de WC blanco
9	SX-SF-643 SX-SF-643-M (Marfil)	Juego de cubre pijas WC blanco
10	SX-RF-1010	Empaque esponjoso para WC 3"

Para cualquier duda sobre refacciones cerámicas comunícate al Departamento Oficina de Refacciones

## WC OPTION 4.8 LPD



#	Modelo	Descripción
1	SX-SF-636	Botón para tapa tanque 4.8 L cromo
2	SX-RF-1080	Tapa para tanque Option
3	SX-SF-942	Kit válvula para tanque Option
4	SX-RF-846	Filtro para válvula de admisión para WC
5	SX-SF-704	Kit de tornillos para sujeción de tanque
6	SX-RF-1224	Empaque de silicón para válvula 3"
7	SX-RF-1010	Empaque esponjoso para WC 3"
8	SX-SF-691	Kit para anclaje de WC blanco
9	SX-SF-643	Juego de cubre pijas WC blanco

Para cualquier duda sobre refacciones cerámicas comunícate al Departamento Oficina de Refacciones

## WC AUSTRAL CON BOTÓN 3.8 LPD



#	Modelo	Descripción
1	SX-SF-636	Botón para tapa tanque 4.8 L cromo
2	SX-RF-1158	Tapa para tanque Austral de botón
3	SX-SF-942	Kit válvula para tanque Austral de botón
4	SX-RF-846	Filtro para válvula de admisión para WC
5	SX-SF-704	Kit de tornillos para sujeción de tanque
6	SX-RF-1010	Empaque esponjoso para WC 3"
7	SX-SF-691	Kit para anclaje de WC blanco
8	SX-RF-1224	Empaque de silicón para válvula 3"

Para cualquier duda sobre refacciones cerámicas comunícate al Departamento Oficina de Refacciones

## WC AUSTRAL CON PALANCA 3.8 LPD



#	Modelo	Descripción
1	SX-SF-884	Palanca para WC Austral
2	SX-RF-1159	Tapa para tanque Austral de palanca
3	SX-SF-883	Kit válvula para tanque Austral de palanca
4	SX-RF-846	Filtro para válvula de admisión para WC
5	SX-SF-704	Kit de tornillos para sujeción de tanque
6	SX-RF-1010	Empaque esponjoso para WC 3"
7	SX-SF-691	Kit para anclaje de WC blanco

Para cualquier duda sobre refacciones cerámicas comunícate al Departamento Oficina de Refacciones

# WC'S

## WC 2.5 2.5 LPD

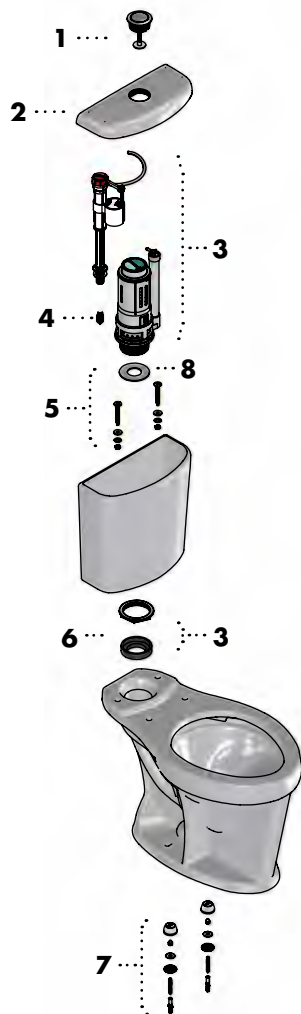

#	Modelo	Descripción
1	SX-SF-636	Botón para tapa tanque 4.8 L cromo
2	SX-RF-1210	Tapa para tanque WC 2.5
3	SX-SF-942	Kit válvula para tanque Austral de botón
4	SX-RF-846	Filtro para válvula de admisión para WC
5	SX-SF-704	Kit de tornillos para sujeción de tanque
6	SX-RF-1010	Empaque esponjoso para WC 3"
7	SX-SF-691	Kit para anclaje de WC blanco
8	SX-RF-1224	Empaque de silicon 3"

Para cualquier duda sobre refacciones cerámicas comunícate al Departamento Oficina de Refacciones

## WC MURANO 4.8 LPD

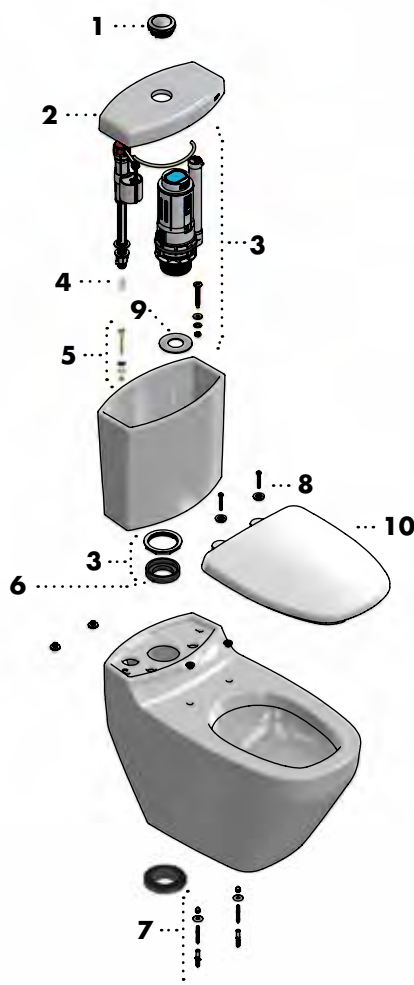

#	Modelo	Descripción
1	SX-SF-636	Botón para tapa tanque 4.8 L cromo
2	SX-RF-1020	Tapa tanque Murano
3	SX-SF-942	Kit de válvula para tanque Murano 3"
4	SX-RF-846	Filtro para válvula de admisión para WC
5	SX-SF-704	Kit de tornillos para sujeción de tanque
6	SX-RF-1010	Empaque esponjoso para WC 3"
7	SX-SF-771	Kit de fijación taza trampa oculta
8	SX-SF-785	Kit de sujeción para asiento AT-4
9	SX-RF-1224	Empaque de silicón para válvula 3"
10	AT-3	Asiento para WC Murano

Para cualquier duda sobre refacciones cerámicas comunícate al Departamento Oficina de Refacciones



## WC MIURA16 4.8 LPD

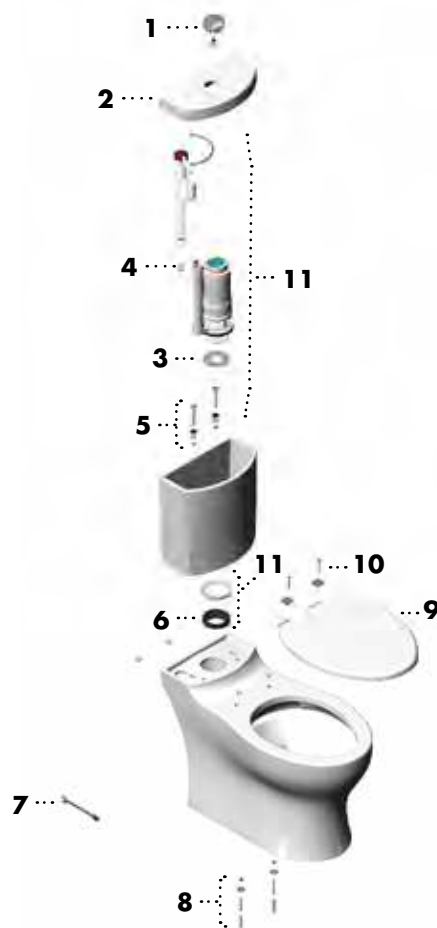

#	Modelo	Descripción
1	SX-SF-636	Botón para tapa tanque 4.8 L cromo
2	SX-RF-1079	Tapa para tanque Miura16
3	SX-RF-1224	Empaque de silicón 3"
4	SX-RF-846	Filtro para válvula de admisión para WC
5	SX-SF-704	Kit de tornillos para sujeción de tanque
6	SX-RF-1010	Empaque esponjoso para WC
7	SX-RF-1106	Llave 7/16"
8	SX-SF-771	Kit de fijación taza trampa oculta
9	AT-5	Asiento cierre lento antibacterial
10	SX-SF-904	Kit de sujeción AT-5
11	SX-SF-942	Kit de válvula de descarga

Para cualquier duda sobre refacciones cerámicas comunícate al Departamento Oficina de Refacciones

## WC MIURA16 TCC 4.8 LPD

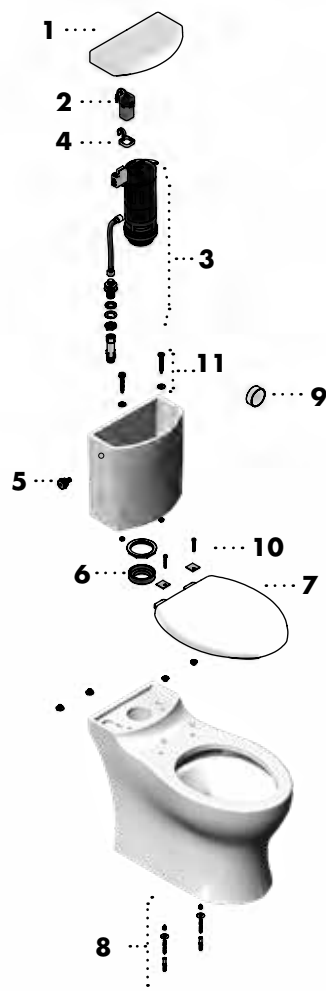

#	Modelo	Descripción
1	SX-RF-1215	Tapa para tanque Miura16 TCC
2	SX-SF-911	Módulo de control
3	SX-SF-912	Kit válvula de descarga
4	SX-RF-1216	Soporte holder
5	SX-SF-913	Botón
6	SX-RF-1010	Empaque esponjoso para WC
7	AT-5	Asiento de cierre lento
8	SX-SF-771	Kit de fijación taza trampa oculta
9	SX-SF-910	Sensor
10	SX-SF-904	Kit de sujeción asiento
11	SX-SF-704	Kit de sujeción para tanque

Para cualquier duda sobre refacciones cerámicas comunícate al Departamento Oficina de Refacciones

## OP RIVOLI PLUS 4.8 LPD

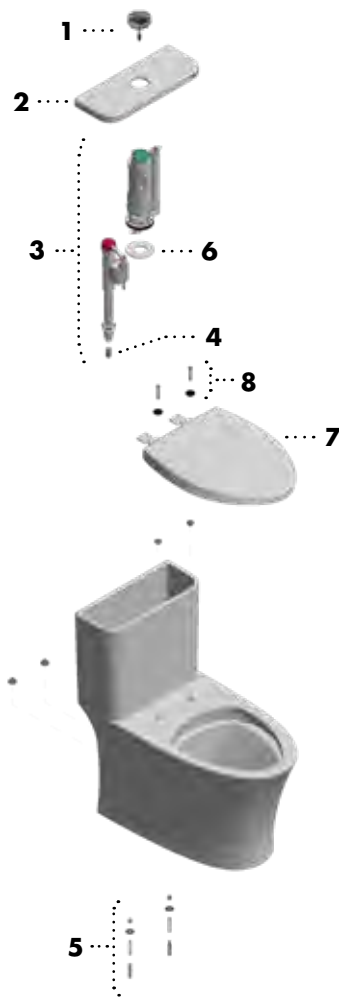

#	Modelo	Descripción
1	SX-SF-636	Botón para tapa tanque 4.8 L cromo
2	SX-RF-1024	Tapa tanque OP Rivoli Plus
3	SX-SF-815	Kit de válvula de admisión y válvula de descarga 3"
4	SX-RF-846	Filtro para válvula de admisión para WC
5	SX-SF-771	Kit de fijación taza trampa oculta
6	SX-RF-1004	Empaque de silicón para válvula 3"
7	AT-4	Asiento cierre lento elongado envoltente antibacterial blanco
8	SX-SF-785	Kit de sujeción para asiento AT-4

Para cualquier duda sobre refacciones cerámicas comunícate al Departamento Oficina de Refacciones

## OP RIVOLI PLUS T 4.8 LPD

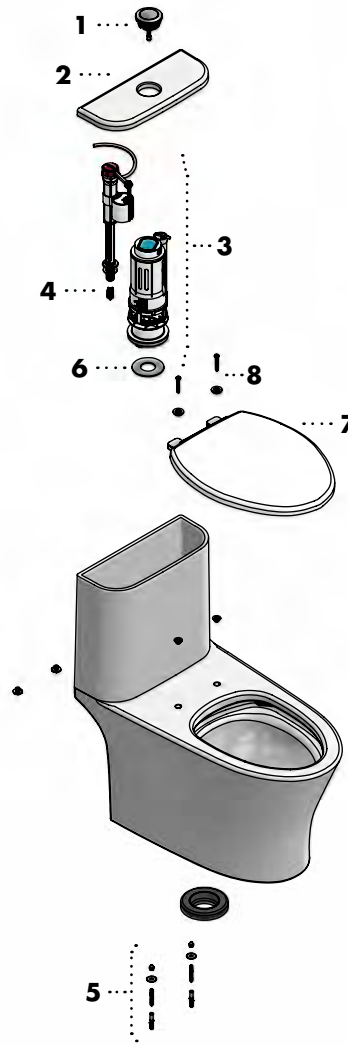

#	Modelo	Descripción
1	SX-SF-636	Botón para tapa tanque 4.8 L cromo
2	SX-RF-1232	Tapa tanque OP Rivoli Plus
3	SX-SF-815	Kit de válvula de admisión y válvula de descarga 3"
4	SX-RF-846	Filtro para válvula de admisión para WC
5	SX-SF-771	Kit de fijación taza trampa oculta
6	SX-RF-1004	Empaque de silicón para válvula 3"
7	AT-4	Asiento cierre lento elongado envoltente antibacterial blanco
8	SX-SF-785	Kit de sujeción para asiento AT-4

Para cualquier duda sobre refacciones cerámicas comunícate al Departamento Oficina de Refacciones

## OP CAPRI PLUS 4.8 LPD

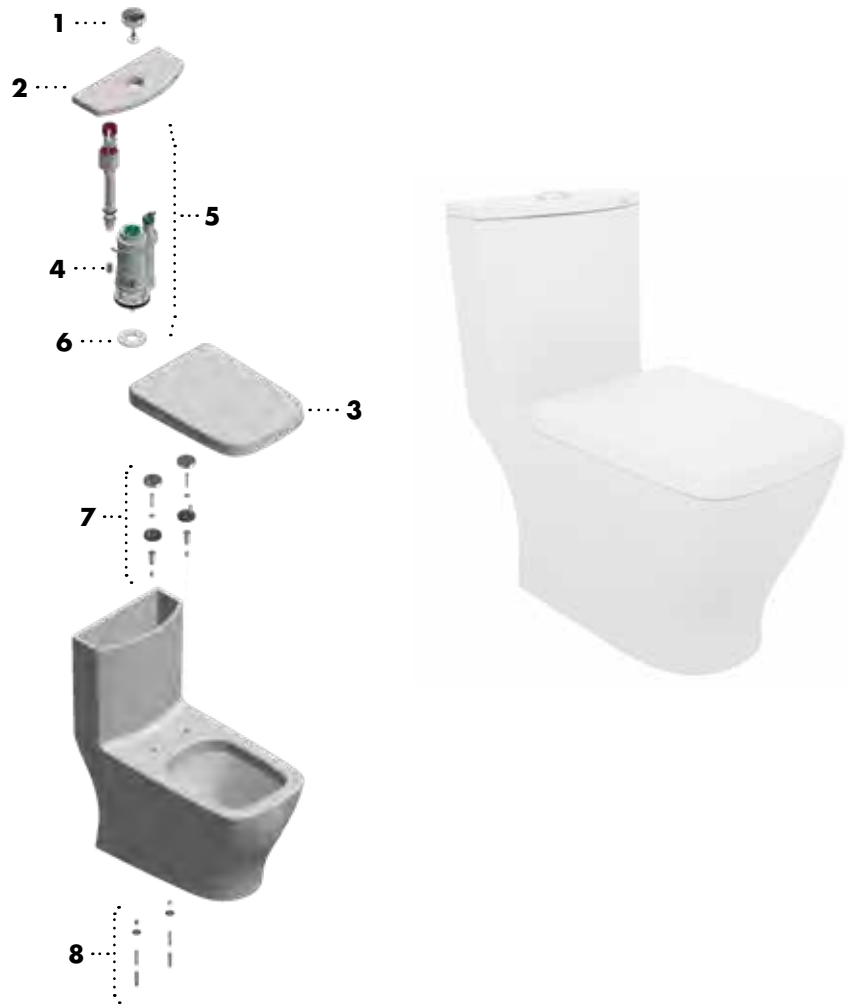

#	Modelo	Descripción
1	SX-SF-636	Botón para tapa tanque 4.8 L cromo
2	SX-RF-1090	Tapa para tanque OP Capri Plus
3	SX-SF-839	Asiento para OP Capri Plus
4	SX-RF-846	Filtro para válvula de admisión para WC
5	SX-SF-842	Kit de válvula para tanque OP Capri Plus
6	SX-RF-1004	Empaque de silicón para válvula 3"
7	SX-SF-840	Kit de sujeción para OP Capri Plus
8	SX-SF-771	Kit de fijación taza trampa oculta

Para cualquier duda sobre refacciones cerámicas comunícate al Departamento Oficina de Refacciones

## TZF TAZA NAO PARED

TRAMPA OCULTA 6 LPD, ECOLÓGICO  
3.5 LPD, 4.8 LPD

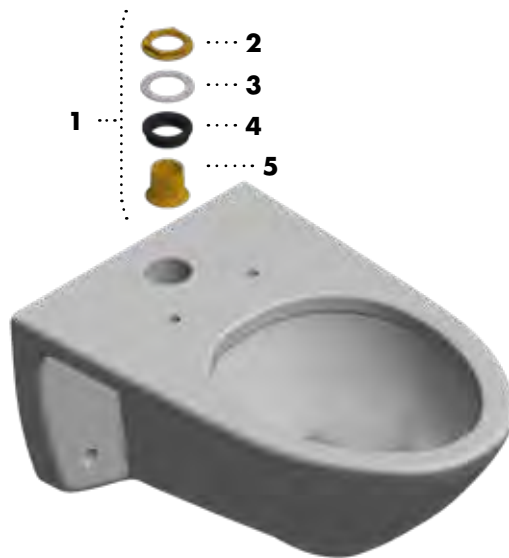

#	Modelo	Descripción
1	SX-SF-648	Spud para taza de 38 mm
2	SX-RF-740	Tuerca plana de WC para fluxómetro spud 38 mm
3	SX-RF-738	Rondana de spud para taza de fluxómetro 38 mm
4	SX-RF-739	Empaque para spud de 38 mm
5	SX-RF-737	Espárrago de WC para fluxómetro spud de 38 mm

Para cualquier duda sobre refacciones cerámicas comunícate al Departamento Oficina de Refacciones



## SOPORTE PARA TAZA S-TZF-P

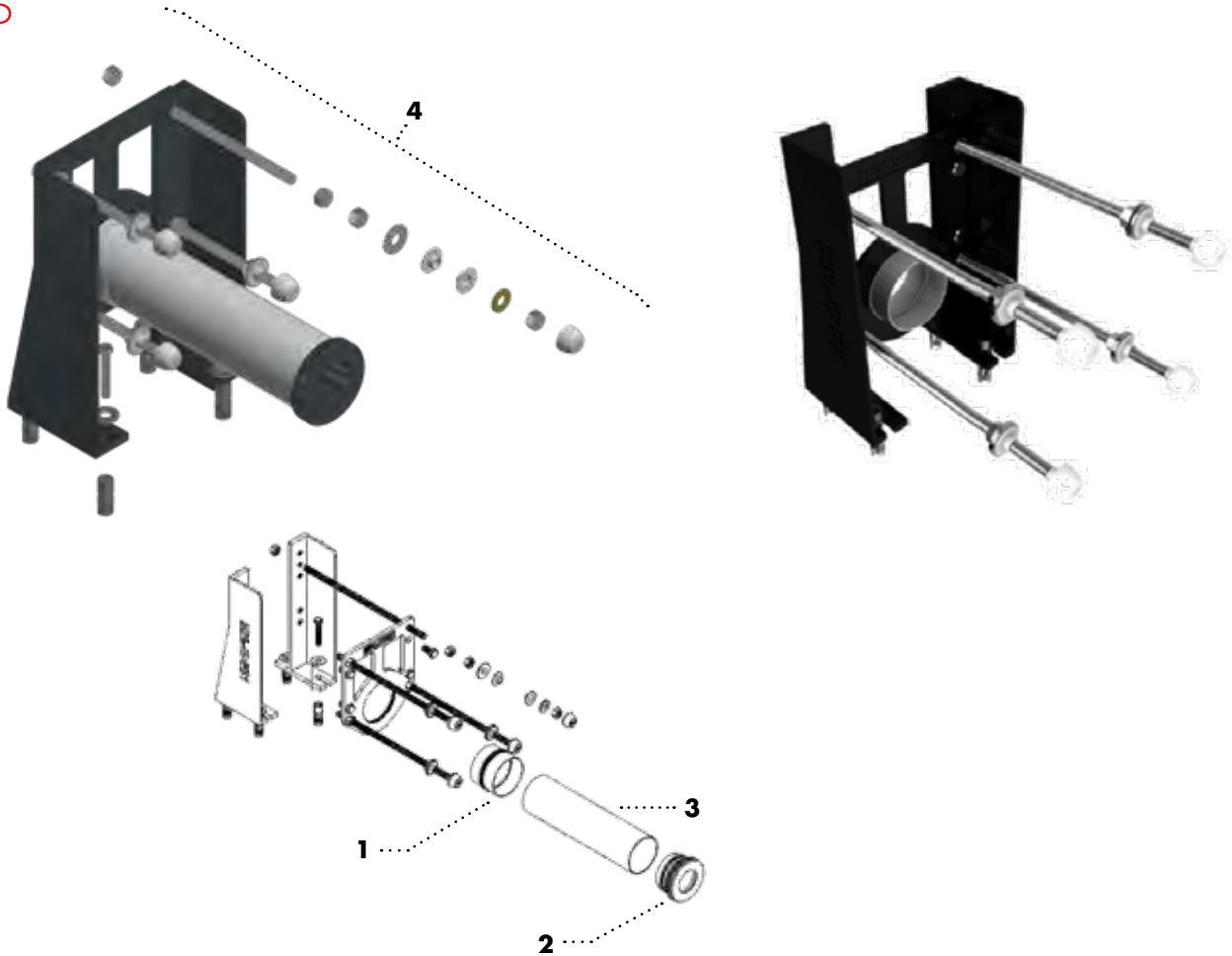

#	Modelo	Descripción
1	SX-RF-967	Cople para taza suspendida 4 3/4"
2	SX-RF-951	Cuello flexible para sanitario 100 mm
3	SX-RF-970	Tubo PVC para cople 4 3/4"
4	SX-SF-798	Juego de tuercas y rondanas para taza suspendida

Para cualquier duda sobre refacciones cerámicas comunícate al Departamento Oficina de Refacciones

## TAZA TZF NAO 3.5 LPD / 4.8 LPD



#	Modelo	Descripción
1	SX-SF-648	Spud para taza de 38 mm
2	SX-RF-739	Empaque para spud de 38 mm
3	SX-SF-691	Kit para anclaje WC blanco
4	SX-SF-643	Juego de cubre pijas para WC blanco

Para cualquier duda sobre refacciones cerámicas comunícate al Departamento Oficina de Refacciones

## TAZA TZF NAO17

3.5 LPD / 4.8 LPD



#	Modelo	Descripción
1	SX-SF-648	Spud para taza de 38 mm
2	SX-RF-739	Empaque para spud de 38 mm
3	SX-SF-691	Kit para anclaje de WC blanco
4	SX-SF-643	Juego de cubre pijas para WC blanco

Para cualquier duda sobre refacciones cerámicas comunícate al Departamento Oficina de Refacciones

## AT-1

### ASIENTO Y TAPA DE CIERRE LENTO ELONGADO

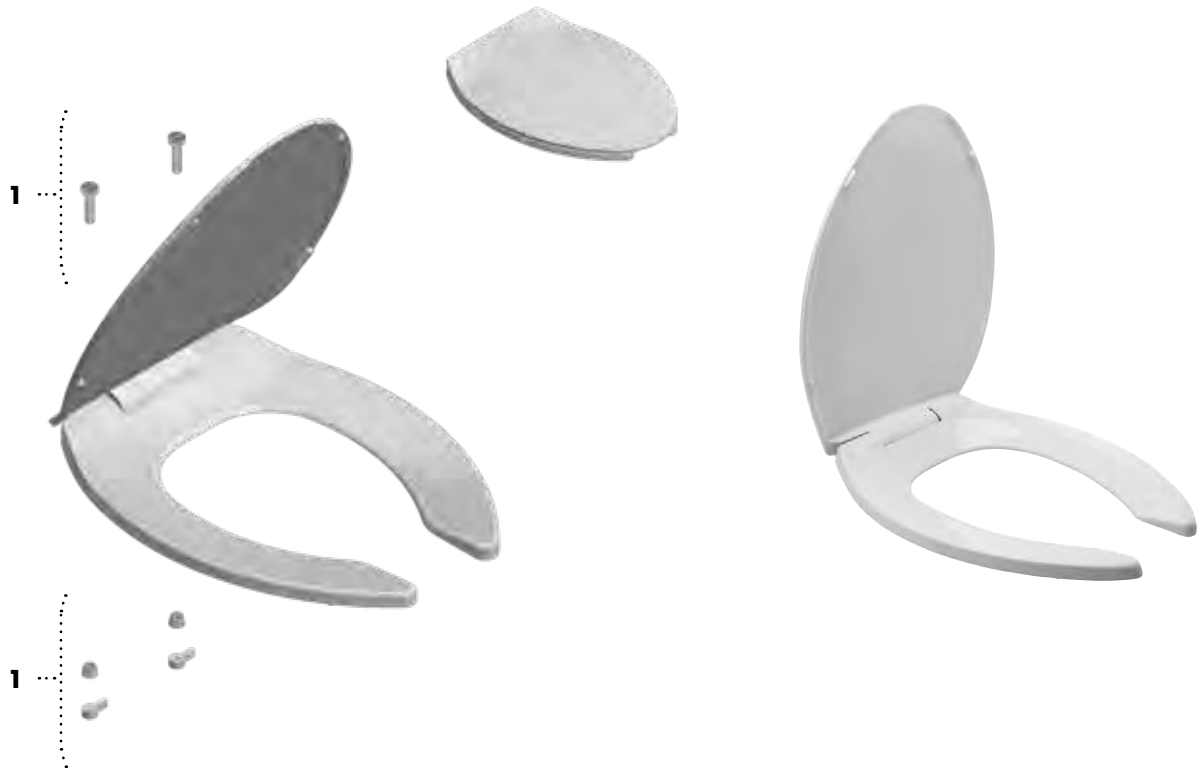

#	Modelo	Descripción
1	SX-SF-734	Kit de sujeción AT-1

Para cualquier duda sobre refacciones cerámicas comunícate al Departamento Oficina de Refacciones

# ASIENTOS DE WC

## AT-2

### ASIENTO CON TAPA DE CIERRE ESTÁNDAR ELONGADO



#	Modelo	Descripción
1	SX-SF-735	Kit de sujeción AT-2

Para cualquier duda sobre refacciones cerámicas comunícate al Departamento Oficina de Refacciones

## AT-4

### ASIENTO CON TAPA ENVOLVENTE DE CIERRE LENTO



#	Modelo	Descripción
1	SX-SF-785	Kit de sujeción para asiento AT-4

Para cualquier duda sobre refacciones cerámicas comunícate al Departamento Oficina de Refacciones



# ASIENTOS DE WC

## AT-5

### ASIENTO CON FRENTE ABIERTO CON TAPA DE CIERRE LENTO



#	Modelo	Descripción
1	SX-SF-904	Kit de sujeción AT-5

Para cualquier duda sobre refacciones cerámicas comunícate al Departamento Oficina de Refacciones

# ASIENTOS DE WC

## ATM

### ASIENTO MECÁNICO CON FUNCIONES TIPO BIDET



#	Modelo	Descripción
1	SB-1247	Kit de sujeción para asiento ATM
2	SB-1250	Manguera para asiento ATE
3	RB-888	Conector para asiento ATM

Para cualquier duda sobre refacciones cerámicas comunícate al Departamento Oficina de Refacciones

# ASIENTOS DE WC

## ATE

ASIENTO ELECTRÓNICO CON  
FUNCIONES DE LIMPIEZA SECADO  
Y CALEFACCIÓN



#	Modelo	Descripción
1	RB-889	Conector para asiento ATE
2	SB-1250	Manguera para asiento ATE
3	SB-1248	Kit de empaques para manguera
4	SB-1234	Control remoto

Para cualquier duda sobre refacciones cerámicas comunícate al Departamento Oficina de Refacciones

# ASIENTOS DE WC

## ATR-1

### ASIENTO CON TAPA DE CIERRE ESTÁNDAR



#	Modelo	Descripción
1	SX-SF-735	Kit de sujeción AT-2

Para cualquier duda sobre refacciones cerámicas comunícate al Departamento Oficina de Refacciones

## AF-1

### ASIENTO SIN TAPA ELONGADO



#	Modelo	Descripción
1	SX-SF-734	Kit de sujeción AT-1

Para cualquier duda sobre refacciones cerámicas comunícate al Departamento Oficina de Refacciones

# ASIENTOS DE WC

## AF-2

### ASIENTO SIN TAPA ELONGADO



#	Modelo	Descripción
1	SB-1147	Kit de sujeción asiento AF-2

Para cualquier duda sobre refacciones cerámicas comunícate al Departamento Oficina de Refacciones

# LAVABOS

## LV FURTURA1

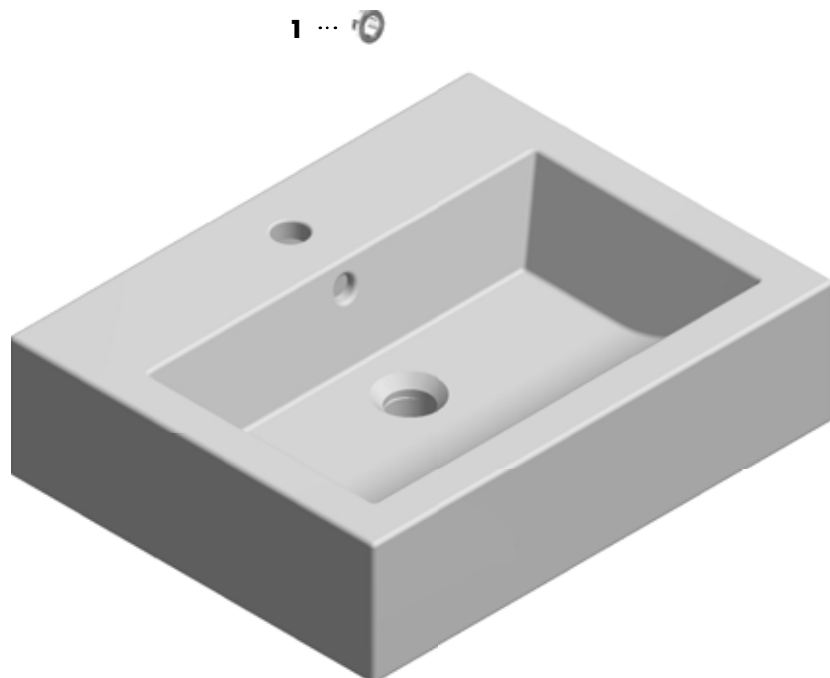

#	Modelo	Descripción
1	SX-RF-1011	Chapetón para Lavabo Futura 1 y 3

Para cualquier duda sobre refacciones cerámicas comunícate al Departamento Oficina de Refacciones



## LV LUCERNA1

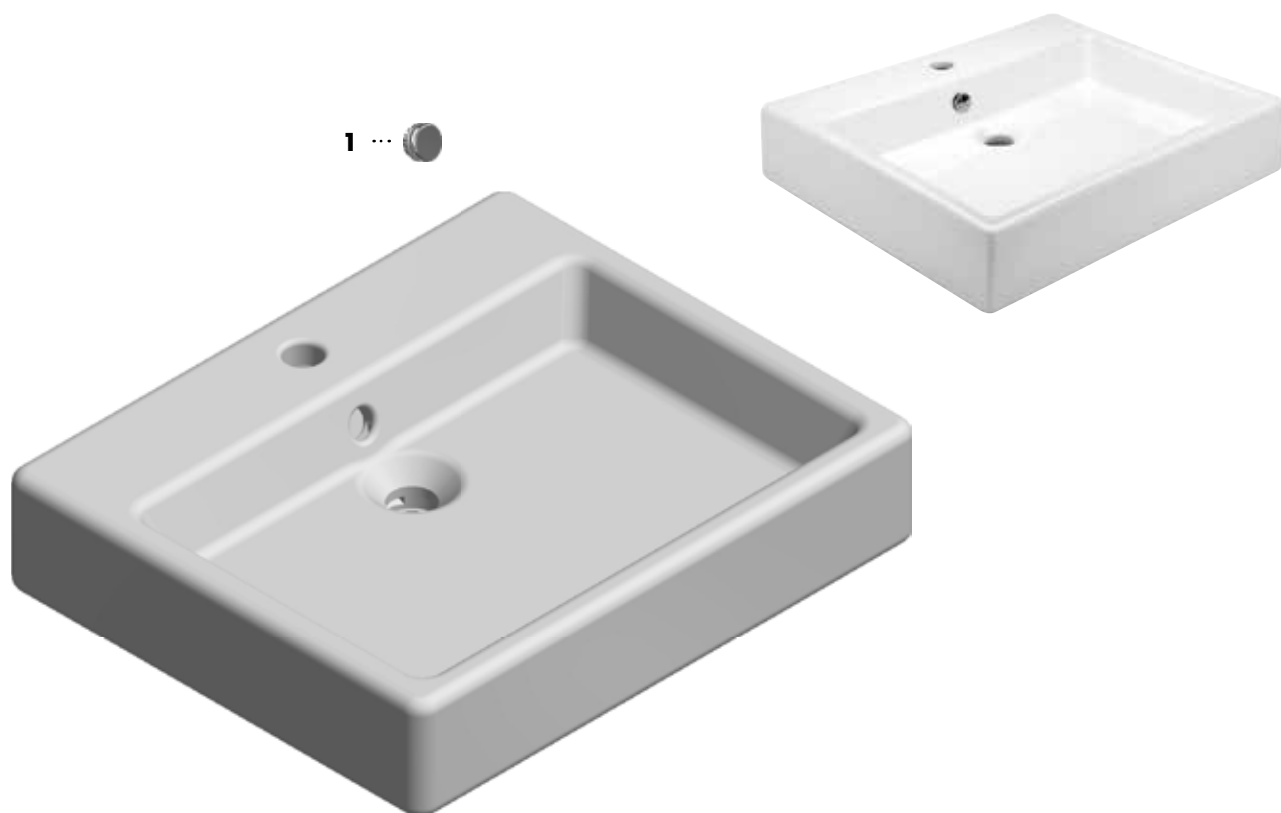

#	Modelo	Descripción
1	SX-RF-898	Chapetón de rebosadero

Para cualquier duda sobre refacciones cerámicas comunícate al Departamento Oficina de Refacciones

## LV LUCERNA3 GDE

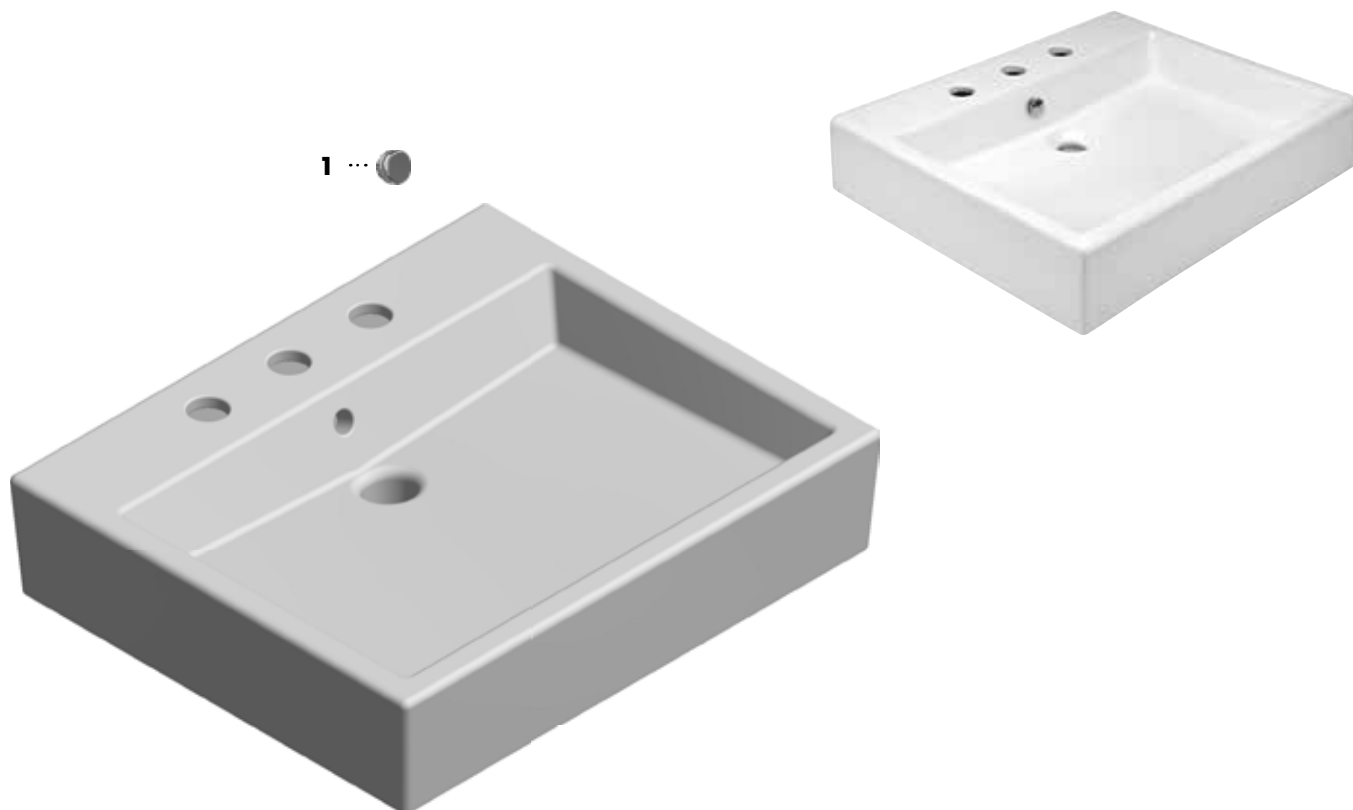

#	Modelo	Descripción
1	SX-RF-898	Chapetón de rebosadero

Para cualquier duda sobre refacciones cerámicas comunícate al Departamento Oficina de Refacciones

## LV SANTORINI1

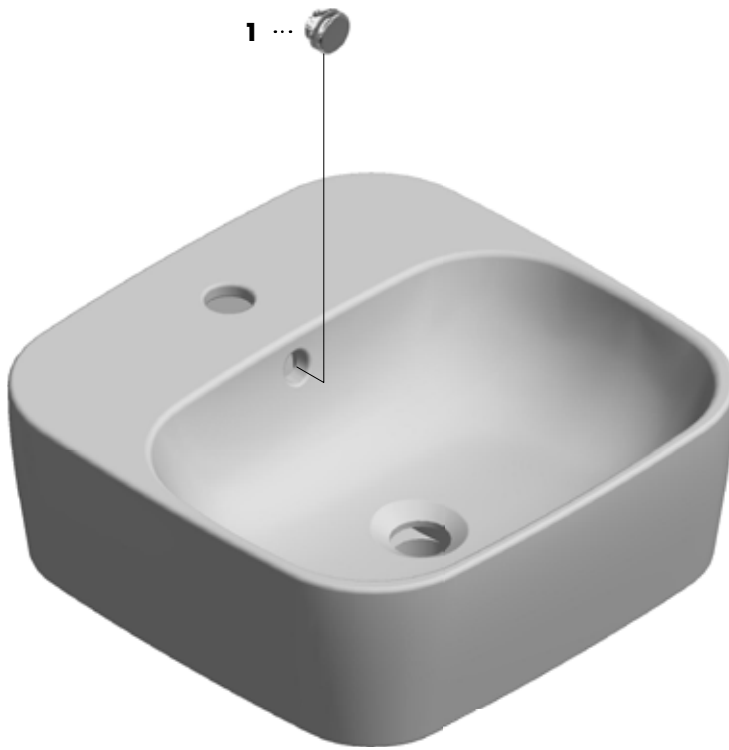

#	Modelo	Descripción
1	SX-RF-898	Chapetón de rebosadero

Para cualquier duda sobre refacciones cerámicas comuníquese al Departamento Oficina de Refacciones

## LV MOREA1

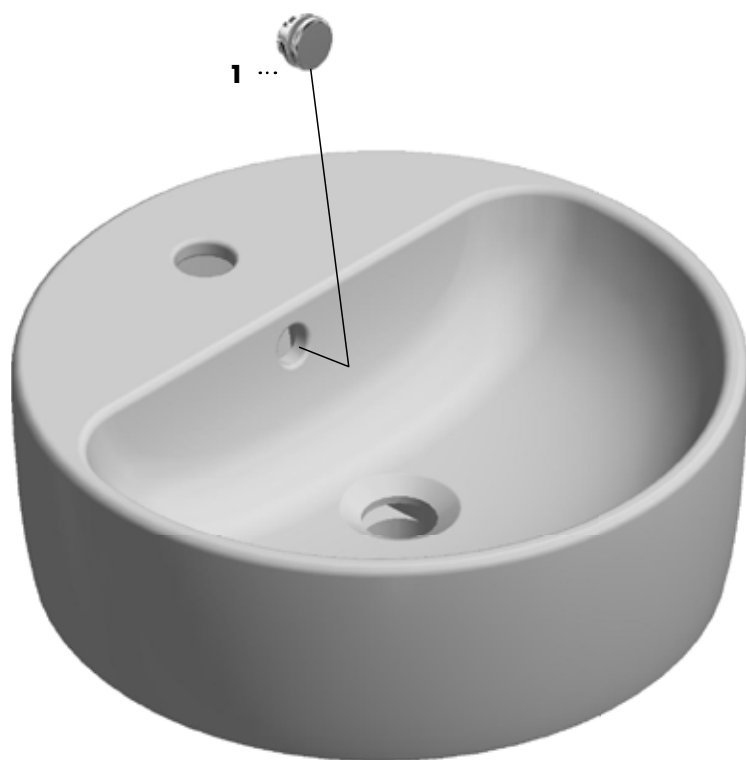

#	Modelo	Descripción
1	SX-RF-898	Chapetón de rebosadero

Para cualquier duda sobre refacciones cerámicas comunícate al Departamento Oficina de Refacciones

# LAVABOS

## LV MARCUS BC

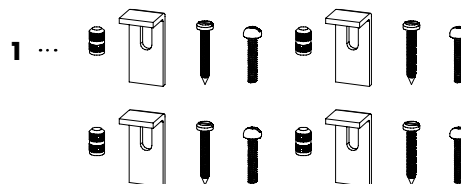

#	Modelo	Descripción
1	SX-SF-794	Kit de sujeción para lavabo

Para cualquier duda sobre refacciones cerámicas comunícate al Departamento Oficina de Refacciones

GUÍA TÉCNICA DE  
**REFACCIONES**

---

- **CARTUCHOS** • **AIREADORES** • **VALVEX**
- **ÉMBOLOS** • **COLADERAS**

Refacciones Originales

**HELVEX**<sup>M.R.</sup>

garantía de calidad

# CARTUCHOS



**Cartucho monomando  
mantis 35mm Diam.  
Vástago plástico  
Mod. SH-374**



**EP-92**



**Cartucho monomando  
Barreno pasado 40 mm Diam.  
Vástago plástico  
Mod. SH-373**



Productos discontinuados: E-36



**E-34  
Nuva**



**E-39  
Elipsis**



**E-305-AAI  
E-305**



**E-308**



**Cartucho monomando  
Barreno lateral derecho  
40 mm Diam.  
Mod. SV-645**



Productos discontinuados:  
E-706, E-707



**E-700  
Vértika**



**E-701  
Vértika**



**E-702  
Premier**



**E-703  
Premier**



**PIU-200**



**PIU-201**



# CARTUCHOS



**Cartucho monomando  
GDM Lavabo 35 mm  
Diam.  
Mod. SH-370**



**EP-3005  
Kúbica**



**E-45  
Novus**



**E-72  
Mantis**



**E-77  
Aqua**



**EP-3003  
Nuva**



Productos  
descontinuados:  
E-94, E-95, E-99, E-900  
E-71, E-73, E-90, E903-AI  
E-931, E-932, E-933, E-25,  
E-712, E-3003



**E-714  
Nautilia**



**EP-3007  
Kúbica**



**E-32  
Nuva**



**E-907  
Explora**



**E-908  
Explora**



**E-307**



**E-300**



**EP-95  
Aqua**



**EP-99  
Nuva**



**E-930**



**EP-945**



**EP-947**



**EP-94  
Kúbica**



**EP-900  
Novus**



**EP-932  
Máxima**



**EP-933  
Máxima**



**Cartucho ecológico armado  
Barreno frontal de 35 mm  
Diam.  
Mod. SH-1057**



**E-907-CE  
Explora**



**E-908-CE  
Explora**

# CARTUCHOS



**Cartucho para monomando Barreno pasado regadera 40 mm Diam. Mod. SV-365**



Productos discontinuados:  
E-57, E-58, E-55, E-55-AI,  
E-56, E-56-AI, E-83, E-84,  
E-713



**E-46 Nuva**



**E-47 Nuva**



**E-48 Kúbica**



**E-49 Kúbica**



**E-59 Explora**



**E-705 Explora**



**E-708**



**E-709**



**E-710**



**E-711**



**Cartucho compensador monomando 40 mm Diam. Vástago plástico Mod. SV-409**



Modelo anterior SV-409-S

Productos discontinuados:  
E-761, E-777, E-778, E-773-AAi,  
E-774-AAi, E-770, E-771,  
E-780, E-781, E-765, E-762,  
E-775, E-776, E-784,  
E-785, E-790, E-792



**E-791**



**E-793**

# CARTUCHOS



**Cartucho para monomando Barreno pasado de 25 mm Vástago metálico Mod. SH-1154**



Productos discontinuados:  
E-918, E-919, E-915, E-910,  
E-905, E-909, E-914



**EP-905**  
Vértika



**EP-909**  
Premier



**E-916**  
Konos



**E-917**  
Konos



**E-948**



**E-949**



**E-924**



**E-925**



**E-928**  
Century



**E-929**  
Squadra



**E-920**



**E-921**



**E-937**  
Squadra



**E-941**



**E-939**



**E-943**



**E-309**



**E-310**



**E-312**



**EP-938**



**E-940**



**Cartucho armado Lavabo a pared 35 mm Diam. Vástago plástico Mod. SH-1045**



Productos discontinuados:  
E-3008, E-3009, E-3010



**EP-3007**  
Vértika



**Cartucho joystick 25 mm Diam. Vástago metálico Mod. SH-1134**



Productos discontinuados:  
E-913, E-27



**PIU-100**  
Plura



**PIU-101**  
Plura

# CARTUCHOS



**Cartucho armado joystick**  
**Lavabo a pared 35 mm**  
**Diam.**  
**Vástago metálico**  
**Mod. SH-1131**

Productos discontinuados: E-3011



**E-306**



**Cartucho d 35 mm ex35 top**  
**Vástago de plástico**  
**Mod. SH-1612**



**LUS-100**



**PIA-100**



**LUS-101**



**PIA-101**



**Cartucho kx d 40 mm**  
**Vástago de plástico**  
**Mod. SV-790**



**E-713**



**Cartucho kx d 35 mm**  
**Vástago de plástico**  
**Mod. SH-1569**



**E-712**



**Cartucho kx d 35 mm**  
**Vástago de plástico**  
**Mod. SV-806**



**LUS-200**

# CARTUCHOS



**Cartucho kx d 35 mm**  
**Vástago plástico**  
**Mod. SV-798**



**PIA-200**



**Cartucho kx d 28 mm**  
**Vástago metálico**  
**Mod. SH-1308**



**E-922**



**E-923**



**Cartucho kx d 25 mm**  
**Vástago metálico**  
**Mod. SH-1598**



**E-950-EB**



**E-951-EB**

# ÉMBOLOS PARA WC



## Émbolo Autolimpieza Mod. SF-774 3 LT

Modelo Anterior  
SF-100 Mecánico  
SF-171 Electrónico



153-19



185-19



285-19



310-19



323-19



410-19



FB-185-19



FC-185-19



## Émbolo Autolimpieza Mod. SF-743 1 LT

Modelo Anterior  
SF-651



185-19-1



285-19-1



310-19-1



323-19-1



410-19-1



FB-185-19-1



FC-185-19-1



## Émbolo Autolimpieza Mod. SF-744 0.5 LT

Modelo Anterior  
SF-600



153-19-0.5



185-19-0.5



285-19-0.5



310-19-0.5



323-19-0.5



410-19-0.5



FB-185-19-0.5



FC-185-19-0.5

# ÉMBOLOS PARA WC



## Émbolo Autolimpieza Mod. SF-719 6 LT

Modelo Anterior  
SF-124 Mecánico  
SF-170 Electrónico



110-32



110-38



117-38



120-32



120-38



122-38



140-38



142-38



150-32



152-32



310-32



310-38



311-32



311-38



312-32



152-38



210-32



210-38



312-38



318-38



410-32



FB-110-32



FC-110-32



## Émbolo Autolimpieza Mod. SF-741 4.8 LT

Modelo Anterior  
SF-591



110-WC-4.8



17-38-4.8



210-WC-4.8



310-WC-4.8



312-WC-4.8



410-WC-4.8



FB-110-WC-4.8



FC-110-WC-4.8

# ÉMBOLOS PARA WC



**Émbolo Autolimpieza**  
**Mod. SF-804 3.5 LT**



**110-38-3.5**



**210-38-3.5**



**FC-110-38-3.5**



**310-38-3.5**



**FB-110-38-3.5**



**FCO110-38-3.5**



# VALVEX



**Val -Vex V Grande Izq. cierre de disco cerámico Mod. SH-1114**

**Val -Vex V Der. cierre de disco cerámico Mod. SH-1012**

**Modelo Anterior SH-265**



**ME-302**



**MEP-2006 Nuva**



**MEP-2115 Premier**



**M-1004 Konos**



**M-1005 Clásica**



**H-1334IG**



**M-1006**



**VCG-2**



**VCG-2T**



**\*E-40-II  
\*E-40-AQ**



**E-50-II  
E-50-AQ**



**E-60-II  
E-60-AQ**



**E-61-II / E-61-S  
E-61-AQ**



**ME-303**



**ME-304**

Productos discontinuados:

E-301, E-302, E-303, E-2007, E-2111-II, E-2113, E-2117, E-9, E6-II, M-03, E-2001, E-2004-II, E-2009-II, E-2114, E-2116, E-2118, E-2119, E-2120, MEV6-V, E-2121, E-2122, E-3000, E-3004, E-2115, M-05, E-2118-DX, ME-2122-1.9

**Nota: El val-vex central del E-40, corresponde al SH -264**

# VÁLVEX



**Val -Vex I Grande  
Izq. mecanismo  
de casquillo  
Mod.  
SH-262**



**MEP-2004**



**E-60**



**E-40**



**E-50**



**Val -Vex I Grande  
der. mecanismo  
de casquillo  
Mod.  
SH-264**



**E-40**



**E-40-II**



**E-40-AQ**



**Val -Vex izq  
p/mezcl. Vertika  
Mod.  
SH-978**



**MP-1000  
Vértika**



**MR-1001  
Vértika**

**Val -Vex Der.  
p/mezcl. Vertika  
Mod.  
SH-979**

Productos discontinuados:  
M-1001, M-1002, M-1001-DX, M-1002-DX,  
Acueducto  
M-1003, M-1002, MR-1003, MR-1004



**Val -Vex II Chico**  
**izq. cierre de disco**  
**cerámico**  
**Mod.**  
**SH-1343**



**Val -Vex II Chico**  
**Chico der. cierre de**  
**disco cerámico**  
**Mod.**  
**SH-1344**



**HM-14**  
**Antares**



**HM-17**  
**Albatros**



**HM-22**  
**Acaya**



**HM-37**  
**Albatros**



**HM-38**  
**Flamingo**



**HM-18**  
**Ántea**



**HM-21**  
**Ática**

Productos  
 descontinuados:  
 E-100, E-101-S/Contra, E-2500,  
 E-304, HM-15,  
 HM-16, HM-20

Nota:  
 Para modelos anteriores del 2016,  
 aplica el Val-Vex II Mod. SH-257.



**Val -Vex I Chico**  
**mecanismo de**  
**casquillo**  
**Mod.**  
**SH-263**



**MI-01-S/C**



**Val -Vex II-A**  
**Mod.**  
**SH-1377 izq.**  
**SH-1376 der.**



**MI-02-S/C**  
**PRIMMA**

Nota:  
 Para modelos anteriores del 2016,  
 aplica el Val-Vex II Mod. SH-257.

# AIREADORES



**Aireador  
Activ s seg  
Mod.  
SH-282**



**MI-01-S/C**



**MI-02-S/C**



**EP-92**



**EP-95**



**TV-298**



**E-928**



**E-929**



**E-930**



**EP-932**



**TV-298-C**



**EP-933**



**E-907  
E-907-CE**



**EP-943**



**H-13341G**



**E-908**



**E-937**



**HM-17**



**HM-18**



**HM-22**



**TV-297**



**TV-304**



**TV-296**



**TV-296-C**



**TV-297-C**



**MEP-2115**



**E-32**



**E-34**

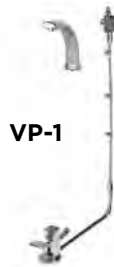

**VP-1**

Productos discontinuados:

E-919, E-100, E-101-S/C, E-2, E-931, HM-15, E-2-11, E-2001, EP-2001, HM-16, HM-20, M-03, E-2117, E-21111, TV-299, TV-399, E-2112, E-900, EP-900, TV-401, TV-402, E-90, E-2009, EP-2009, E-2115, ME-5, ME-6, E-918

## Aireadores compatibles para ahorro de agua

**SH-855** 8.3 lts/min

x Pieza



**SB-1014** 5.67 lts/min

Kit de 5 piezas



**SH-1091** 1.9 lts/min  
SPRAY

Kit de 5 piezas



Compatibilidad Se requiere mínimo 1 kg de presión

# AIREADORES



**Aireador para llave economizadora 8.3 lts/min**  
Mod. SH-855



TV-122



TV-203  
TV-203-C



TV-120

## Aireadores compatibles para ahorro de agua

**SH-282**

x Pieza



**SB-1014** 5.67 lts/min

Kit de 5 piezas



**SH-1091** 1.9 lts/min  
SPRAY

Kit de 5 piezas



Compatibilidad Se requiere mínimo 1 kg de presión



**Aireador oculto**  
M24 x 1G STD 8.3 lts/min  
Mod. SH-1135



TV-121

## Aireadores compatibles para ahorro de agua

**SH-1112** flujo libre

x Pieza



**SV-605** 1.9 lts/min  
SPRAY OCULTO

M 24 x 1



**RH-2197** Llave aireador

Compatibilidad Se requiere mínimo 1 kg de presión

# AIREADORES



**Aireador para salida Nuva Mod. RH-1393**



**MEP-2006**



**E-300**



**EP-3003**



**EP-3005**



**E-308**



**E-917**



**EP-94**



**EP-99**



**ME-302**



**HM-14**



**HM-21**



**HM-37**



**HM-38**



**VCG-2**



**EP-945**



**TV-305**



**E-917**



**EP-947**



**TV-200**



**TV-190**



**M-1005**



**VP-2**

Productos discontinuados:

E-2113, E-2114, EP-2114, E-2116, EP-2116, E-2500, E-3004, E-301, E-302, E-303, E-304, E-904, M-05, VCG-2T, TV-201, TV-405, TV-400

## Aireadores compatibles para ahorro de agua

**SB-1011** 5.67 lts/min

Kit de 5 piezas



**SB-1013** 8.31 lts/min

Kit de 5 piezas



**SV-604** 1.9 lts/min

X pieza



**RH-1395** Llave aireador

Compatibilidad Se requiere mínimo 1 kg de presión

# AIREADORES



**Aireador oculto  
para monomando  
lavabo E-909  
Mod. SH-1112**



**EP-909**



**EP-938**

Productos discontinuados:

M-1003, E-913, E-906, E-2119, E-2120, E-914, EP-914,  
E-915, EP-915, E-3011



**RH-2197** Llave aireador

## Aireadores compatibles para ahorro de agua

**SH-1135** 8.3 lts/min

x Pieza



**SV-605** 1.9 lts/min

x Pieza



Compatibilidad Se requiere mínimo 1 kg de presión



**Aireador  
rectangular PL-RC  
32 x 8 IT  
Mod. SH-1143**



**E-905  
EP-905**

Productos discontinuados:

E-3009



**RH-2223** Llave aireador

# AIREADORES



**Aireador rectangular monomando Vértika Mod. SH-1122**



**M-1000**



**EP-3007**

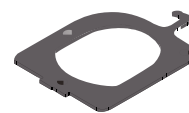

**RH-2223**

Llave aireador

Productos discontinuados:  
E-3010, E-3010-DX, TV-303



**Aireador oculto slim Mod. SH-1254**



**E-920**



**E-921**



**E-922**



**E-923**



**E-924**



**E-925**



**PIU-100**



**PIU-101**



**TV-302**



**M-1006**



**EP-909**



**E-941**



**EP-938**



**E-940**



**E-939**



**E-950-EB**



**E-951-EB**

Productos discontinuados:  
M-1006

## Aireadores compatibles para ahorro de agua

**SH-1329** 6 lts/min



**RH-2736** Llave aireador



# AIREADORES



**Aireador oculto  
slim  
Mod. SH-1587**



**LUS-100**



**LUS-101**



**PIA-100**



**PIA-101**



**Aireador oculto  
slim  
Mod. SV-590**



**E-916**



**M-1004**



**Aireador oculto  
slim  
Mod. SH-1558**



**E-948**



**E-949**

# ECONOMIZADORES DE REGADERA



**Economizador 6  
LTS / MIN  
Mod. SB-1016**

**Kit 1 pza**



AC110-6



H-100-6



H200-6



H201-6



H500-6



H3005-6



H3006-6



RM22-6

**Compatible con los siguientes economizadores**

Productos  
descontinuados:  
H-200-S/BCH



SR-080

**Economizador  
10 lts/min  
1 pza**



SR-169

**Economizador  
E-US TYPE 2.00  
GPM 7.6 lts/min  
1 pza**



**Economizador  
E-US 2.0 gpm  
(7.6 lts/min)  
Mod. SR-169**

**Kit 1 pza**



AC110-8



H500-8

**Compatible con los siguientes economizadores**

Productos  
descontinuados:  
AC20-8, AC30-8, AC50-8



SR-080

**Economizador  
10 lts/min  
1 pza**



SB-1016

**Economizador  
6lts/min  
kit 1 pza**

# ECONOMIZADORES DE REGADERA



**Economizador 10  
LTS / MN  
Mod. SR-080**  
Kit 1 pza



## Compatible con los siguientes economizadores

Productos  
descontinuados:

AC-110, AC-20, AC-30, AC-50,  
H-104, H-106, H-300, H-400, H-800,  
H-1000, H-2000, H-3001, H-103,  
H-905, H-901, RM-11, H-700, RM-8,  
RM-10, RM-12



**SR-169**

**Economizador  
E-US 2.0 gpm  
(7.6 lts/min)  
1 pza**



**SB-1016**

**Economizador  
6 lts/ min  
1 pzas**

# COLADERAS DE REJILLA Y CÚPULAS



**RC-011** Rejilla de contra



**282-H**



**1342-H**



**RC-033** Tapa ciega



**26**

Puede convertirse a desagüe con el modelo:



Puede convertirse a ciega con el modelo:

**RC-018**



Tornillo niquelado No.10 RC-012



**RC-020**



Tornillo niquelado No.10 RC-012



**RC-020** Rejilla de contra



**27**



**28**



**24**



**25**



**342-R**



Puede convertirse a ciega con el modelo:

**RC-033**



Tornillo niquelado No.10 RC-012

# COLADERAS DE REJILLA Y CÚPULAS



**RC-100**  
Rejilla cuadrada



Puede convertirse a ciega con el modelo:  
**RC-134**



Tornillo niquelado No.10  
RC-012



**24-CH**



**25-CH**



**342-C**



**RC-037**  
Rejilla cuadrada



Puede convertirse a ciega con el modelo:  
**RC-074**



Tornillo niquelado No.10  
RC-012



**282-35-CH**



**1342-35CH**



**RC-104**  
Cúpula p/contra coladera



**24-HL**



**25-HL**



**24-CHL**



**25-CHL**

# COLADERAS DE REJILLA Y CÚPULAS



**RC-143**  
Cúpula redonda chica



**24-HLI**



**25-HLI**



**SC-042**  
Porta inserto  
cuadro chico



**24-CHLI**



**25-CHLI**



**28-CHLI**



**RC-110**  
Cúpula p/contra  
coladera



**282-35-CHL**



**1342-35-CHL**



**RC-145**  
Cúpula redonda grande



**282-HLI**



**1342-HLI**



**RC-108**  
Cúpula p/contra  
coladera



**282-HL**



**1342-HL**

# COLADERAS DE REJILLA Y CÚPULAS



**SC-043**  
Porta inserto cuadro grande



**282-35-CHLI**



**1342-35-CHLI**



**RC-073**  
Cúpula de coladera



**444**



**444-X**



**RC-078**  
Cúpula de coladera



**446-X**



**RC-030**  
Rejilla rectangular



**2714**



**RC-027**  
Rejilla coladera



**2514**



# COLADERAS DE REJILLA Y CÚPULAS



**RC-148**  
Cúpula p/rebosadero



**342-CL**



**342-RL**



**RC-062**  
Rejilla contra coladera



**632-H**



Tornillo niquelado  
No.10  
RC-012



**RC-043**  
Rejilla para coladera



**4954**



**RC-009**  
Rejilla canasta



**5424**



**RC-048**  
Rejilla ciega  
con casquillo



**2584**

**SC-008**  
Rejilla con  
marco



# COLADERAS Y CASQUILLOS



**RC-016**  
Casquillo contra grande



1342-35CH



282-35-CHLI



282-H



1342-H



282-35CH



1342-35-CHLI



**RC-024**  
Casquillo para coladera



27



28



**RC-032**  
Casquillo contra chica



25



24-CHLI



24



24-CH



25-CH



26



25-CHLI

# COLADERAS Y CASQUILLOS



## RC-106

Casquillo contra grande



24-HLI



24-HL



24-CHL



25-CHL



25-HL



25-HLI



## RC-111

Casquillo grande



1342-HL



1342-HLI



282-HLI



282-HL



282-35-CHL



1342-35-CHL

# CONTRAS ARMADAS



**SC-011**  
Rejilla con casquillo  
para coladera



**1342-H**



**282-H**



**SC-016**  
Rejilla con casquillo  
para coladera



**24**



**25**



**SC-020**  
Rejilla ciega para  
coladera con casquillo



**26**



**SC-021**  
Contra armada  
redonda  
lisa chica.



**24-HL**



**25-HL**



**SC-022**  
Contra armada  
cuadrada  
lisa chica.



**24-CHL**



**25-CHL**

# CONTRAS ARMADAS



**SC-023**  
Contra armada  
redonda  
lisa grande



**282-HL**



**1342-HL**



**SC-024**  
Rejilla con casquillo  
para coladera



**27**



**28**



**SC-028**  
Rejilla Acero  
Inoxidable  
con casquillo



**282-35CH**



**1342-35CH**



**SC-036**  
Contra armada  
para coladera



**24-HLI**



**25-HLI**



**SC-037**  
Contra armada  
redonda para coladera



**282-HLI**



**1342-HLI**

# CONTRAS ARMADAS



**SC-040**  
Contra armada para coladera



**24-CHLI**



**25-CHLI**



**SC-041**  
Contra armada cuadrada para coladera



**282-35-CHLI**



**1342-35-CHLI**



**SC-025**  
Contra armada lisa cuadrada grande



**282-35-CHLI**



**1342-35-CHLI**



**SC-049**  
Contra armada para coladera



**SC-064**  
Contra armada para coladera



**24-RHLI**



**24-RHLI-60**



**SC-066**  
Contra armada para coladera



**24-RHLI-90**

# MANTENIMIENTO PREVENTIVO CORRECTIVO

Modelo	Preventivo Descripción	Correctivo Descripción
<b>TV -105</b> 	<b>RA-345</b> Resorte de compresión <b>RV-268</b> Empaque boquilla salida econo. <b>SH-1378</b> Economizador 5.0 LPM	 <b>SV-064</b> Kit perilla salida economizadora
<b>TV -120</b> 	<b>SV-632</b> Vastago válvula push con O'ring <b>SV-633</b> Kit de empaques para válvula push	<b>SV-348</b> Cartucho economizador cierre automático TV-120 <b>SH-855</b> Aireador para llave economizadora 8.3 lt. 7 min <b>SV-504</b> Válvula check para salida econ. push TV-120
<b>TV -297</b> 	<b>SV-632</b> Vastago válvula push con O'ring <b>RV-660</b> Pila litio CR-P2-6V p/flux y llave elec	<b>SV-359</b> Electroválv D 6v 1/2" NVA <b>SV-504</b> Válvula check para salida econ. push TV-120 <b>SH-282</b> aireador activ. S. seg CR <b>SV-362</b> Porta pilas NVO
<b>110-38</b> 	<b>SF-054</b> Kit émbolo regul. para fluxómetro <b>SF-055</b> Kit llave de retención <b>SF-056</b> Kit manija y pedal de fluxómetro <b>SF-059</b> kit rondanas spud de 38mm	<b>SF-719</b> Émbolo fluxómetro 6 LPF autolimpieza <b>SF-015-C</b> Mecanismo cierre llave de retención <b>SF-110</b> Estopero arm. con cuerda para fluxómetro
<b>FB-110-32</b> 	<b>SF-054</b> Kit émbolo reg. para fluxómetro <b>SF-055</b> Kit llave de retención <b>SF-058</b> Kit rondana spud de 32 mm <b>RV-660</b> Pila de litio para fluxómetros y llaves elec. <b>SF-760</b> Kit de empaques para carcasa <b>SF-157</b> Perno arm. para flux elec NK <b>SF-761</b> Kit de empaques para botón	<b>SF-719</b> Émbolo fluxómetro 6 LPF autolimpieza <b>SF-015-C</b> Mecanismo cierre llave de retención <b>SV-359</b> Electroválvula 6v-1/2" <b>SF-764</b> Porta baterías flexible <b>SF-177</b> Cople interno con perno armado <b>SF-586</b> Botón accionador mecánico para flux. electrónico
<b>FB-185-19</b> 	<b>SF-054</b> Kit émbolo fluxómetro <b>SF-055</b> Kit llave de retención <b>SF-057</b> Kit rondanas spud de 19 mm <b>RV-660</b> Pila de litio para fluxómetros y llaves <b>SF-760</b> Kit de empaques para carcasa <b>SF-157</b> Perno niquelado para cople <b>SF-761</b> Kit de empaques para botón	<b>SF-774</b> Émbolo fluxómetro 3 LPF autolimpieza <b>SF-015-C</b> Mecanismo cierre llave de retención <b>SV-359</b> Electroválvula 6v-1/2" <b>SF-764</b> Porta baterías flexible <b>SF-177</b> Cople interno con perno armado <b>SF-586</b> Botón accionador mecánico para flux. electrónico



DISTRIBUIDORES  
**AUTORIZADOS**

---

REFACCIONES ORIGINALES

Refacciones Originales

**HELVEX**

M.R.

garantía de calidad

# A NIVEL NACIONAL

AGUASCALIENTES · BAJA CALIFORNIA · BAJA CALIFORNIA SUR · CAMPECHE · CHIAPAS  
CHIHUAHUA · CDMX · COAHUILA · COLIMA · DURANGO · ESTADO DE MÉXICO · GUANAJUATO  
GUERRERO · HIDALGO · JALISCO · MICHOACÁN · MORELOS · NAYARIT · NUEVO LEÓN  
OAXACA · PUEBLA · QUERÉTARO · QUINTANA ROO · SAN LUIS POTOSÍ · SINALOA  
SONORA · TABASCO · TAMAULIPAS · TLAXCALA · VERACRUZ · YUCATÁN · ZACATECAS



- BAJÍO
- CENTRO
- METROPOLITANA
- NORESTE
- PACÍFICO
- SURESTE



**113**

**PUNTOS DE VENTA A NIVEL NACIONAL.**



# CDMX Y ÁREA METROPOLITANA

ÁLVARO OBREGÓN · AZCAPOTZALCO · BENITO JUÁREZ · COYOACÁN · CUAUHTÉMOC  
· IZTAPALAPA · MIGUEL HIDALGO · VENUSTIANO CARRANZA

NAUCALPAN · NEZAHUALCÓYOTL · TLALNEPANTLA · TOLUCA



**15** PUNTOS DE VENTA EN CDMX Y  
ÁREA METROPOLITANA.

**ESTADO****DISTRIBUIDOR****DIRECCIÓN****TEL****ZONA METROPOLITANA**

<b>CDMX</b>	COMPAÑÍA FERRETERA TLALOC DEL SUR SA. DE C.V	Av. División del Norte No. 2318, Col. Portales sur Del. Benito Juárez C.P. 03300	<b>(55) 56-88-06-33</b>
<b>CDMX</b>	CASA HADID	División del Norte #2318, Col. Portales C.P. 03300	<b>(55) 55-84-11-99</b>
<b>CDMX</b>	RISUHE S.A DE C. V	Rómulo O'Farril No. 466, Bodega 45, Col. Olivar de los Padres, Del. Álvaro Obregón C.P. 01780	<b>(55) 56-58-99-49</b> <b>(55) 56-58-96-95</b>
<b>CDMX</b>	MUEBLES PARA BAÑO S.A. DE C.V.	Ayuntamiento 46-B 06010 Col. Centro Del Cuauhtémoc	<b>(55) 55-12-97-00</b> <b>(55) 55-21-72-19</b> <b>(55) 55-21-95-66</b>
<b>CDMX</b>	MUEBLES PARA BAÑO S.A. DE C.V.	Asistencia Publica No. 72, Col. Federal C.P.15700 Venustiano Carranza	<b>(55) 51-33-63-03</b> <b>ext. 2017, 2020,</b> <b>2024, 2018</b>
<b>CDMX</b>	EL SURTIDOR DE OBSERVATORIO	Av. Observatorio No 260, Col Daniel Garza C.P. 11830, Del. Miguel Hidalgo	<b>(55) 52-37-03-00</b> <b>(55) 14-50-90-00</b>
<b>CDMX</b>	EL SURTIDOR DE TULYEHUALCO	Av. Tláhuac 1479 Col. San Nicolás Tolentino C.P. 09850 Del. Iztapalapa	<b>(55) 52-37-03-55</b> <b>(55) 54-26-61-63</b>
<b>CDMX</b>	LLANO DE LA TORRE	División del Norte 2113 Col. Santa Cruz Atoyac alcaldía Benito Juárez, CP 03310 CDMX	<b>(55) 55 56 88 14 99</b> <b>(55) 55 56 88 20 22</b>
<b>CDMX</b>	GRUPO FERREBAÑOS S.A. DE C.V.	Norte 35, No. 927. Col. Industrial Vallejo, Del. Azcapotzalco, C.P. 02300	<b>(55) 51-18-32-00</b>
<b>CDMX</b>	COMERCIALIZADORA Y FERRETERA SHUMA	Av. División del Norte 2825, Col. del Parque Del. Coyoacan C.P. 04040	<b>(55) 55-49-89-99</b>
<b>CDMX</b>	DISTRIBUIDORA DE REFACCIONES HELVETIA, S.A. De.CV.	Dr. Erazo , No 27-C, Col Doctores, C.P. 06720 Del. Cuauhtémoc	<b>(55) 55-88-22-07</b> <b>(55) 55-88-22-03</b>
<b>CDMX</b>	TECNO BAÑOS S.A. DE C.V	Centlapan No. 28 Edif. B-101, Col. San Martín Xochinahuac, Del. Azcapotzalco C.P. 02120	<b>(55) 53-83-96-20</b> <b>(55) 53-83-71-76</b>
<b>Edo. de Méx.</b>	UNIÓN DE DISTRIBUIDORES MAYORISTAS S.A. DE C.V.	Calle plásticos No 21 K, Col San Francisco Cuautlalpan, Naucalpan de Juarez C.P. 53569	<b>(55) 55-46-50-97</b> <b>(55) 55-46-49-30</b>
<b>Edo. de Méx.</b>	EL SURTIDOR DE OBSERVATORIO S.A. DE C.V. TLANEPANTLA	Autopista Mex-Qro. 3069-A Tequesquinahuac C.P. 54020, Tlanepantla de baz Edo. de México	<b>(55) 52-37-03-99</b> <b>(55) 53-90-37-55</b>
<b>Edo. de Méx.</b>	SANIGAR S.A. DE C.V.	Av. Ángel de la Independencia No. 29 2a. Sección, Col. Metropolitana, Nezahualcóyotl, C.P. 57740	<b>(55) 57-65-09-06</b> <b>(55) 57-65-29-84</b>

**ESTADO****DISTRIBUIDOR****DIRECCIÓN****TEL****ZONA CENTRO**

<b>Toluca</b>	MUEBLES PARA BAÑO S.A. DE C.V.	Paseo Tollocan 110 Col. Ampliación Lázaro Cárdenas Toluca, C.P. 50180	<b>(722) 2-19-51-21</b> <b>(722) 2-17-51-79</b>
<b>Puebla</b>	MUEBLES PARA BAÑO S.A DE C.V.	25 Poniente No 3504, Col. Belisario Domínguez, Puebla Pue. C.P. 72180	<b>(222) 2-49-77-61</b>
<b>Puebla</b>	FERNANDO MORENO MEJIA	25 Poniente No. 717, Col. Insurgentes Chula vista, Puebla, C.P. 72420	<b>(222) 240-94-12</b> <b>(222) 240-94-21</b>
<b>Puebla</b>	GABINO FERNANDO MORENO DIAZ	27 Poniente No. 510, Col. Chula vista, Puebla Pue. C.P. 72180	<b>(222) 237-63-02</b>
<b>Puebla</b>	ACABADOS SHUMA S.A. DE C.V.	Recta cholula No. 8, Cuautlancingo, Puebla, C.P. 72730, Col. Bello Horizonte	<b>(222) 284-7272</b> <b>(222) 284-2967</b>
<b>Puebla</b>	DECORAMICA S.A. DE C.V.	21 Sur No. 2501 Esq. 25 Poniente, Col. Los volcanes, Puebla Pue. C.P. 72410	<b>(222) 298-3535</b>
<b>Puebla</b>	TUBERIAS DE ORIENTE	Gran Avenida No. 3621, Col. Las cuartillas, Puebla, Pue. C.P. 72050	<b>(222) 122-22-22</b>
<b>Tehuacán, Puebla</b>	BRICOPAT	Calzada Adolfo López Mateos #4215, San Lorenzo Teotipilco C.P. 75855, Tehuacán Puebla,	<b>(238) 382-3561</b> <b>(238) 328-3238</b>
<b>Querétaro</b>	PLOMERÍA Y CERÁMICA DE QUERÉTARO S.A.DE C.V.	Pról. Corregidora Sur No. 191, Fracc. Balastradas, Querétaro Qro. C.P. 76070	<b>(442) 213-4401</b>
<b>Querétaro</b>	MUEBLES PARA BAÑO S.A. DE C.V.	Pról. Luis Pasteur Sur, No. 418-A, Col. Valle alameda, Querétaro Qro. C.P. 76040	<b>(442) 212-6559</b> <b>(442) 214-1950</b>
<b>Querétaro</b>	AZUPISO SA. DE C.V.	Av. 5 de Febrero No. 1606, Col. San Pablo, Querétaro Qro. C.P. 76130	<b>(442) 217-0777</b>
<b>Veracruz</b>	FERNANDO REQUEJO S.A. DE C.V.	Gómez Farias 1186, Col. Flores Magon Centro Veracruz, Veracruz	<b>(229) 932-32-20</b> <b>(229) 932-36-54</b>
<b>Veracruz</b>	CASA REQUEJO S.A DE C.V.	Urano 31 y 32, Col. Jardines de Mocambo, Boca del Rio Veracruz, C.P. 94299	<b>(229)922-94-49</b> <b>(229)922-90-18</b>
<b>Veracruz</b>	MUEBLES PARA BAÑO S.A. DE C.V.	Miguel Alemán No. 610, Esq. Altamirano, Col. Salvador Diaz Mirón, Ver., Ver. C.P. 91909	<b>(229) 931-3216</b> <b>(229) 931-3334</b>
<b>Veracruz</b>	TUBERIAS DE ORIENTE	Manuel J Clouthier 6856, Amapolas Veracruz, Veracruz C.P. 91697	<b>(229)-920-34-24</b>
<b>Veracruz</b>	ACEROS Y MATERIALES ALBA	Bldv. Adolfo Ruiz Cortinez, No. 101, Col. Flores Magon, Poza Rica Veracruz, C.P. 93340	<b>(782) 826-30-50</b> <b>(782) 826-30-40</b>
<b>Guerrero</b>	ISIDRO OVEJAS S.A. DE C.V.	Bldv.de las naciones #37 L. 10, plaza comercial la joya, Col. Granjas del marquez, Acapulco Gro., C.P. 39890	<b>(744) 466-4629</b>
<b>Guerrero</b>	MV SA DE CV	Av. Farallón No 408, Fracc. Farallón del Obispo, Acapulco Gro. C.P. 39690	<b>(744) 469-9020</b>

## ESTADO

## DISTRIBUIDOR

## DIRECCIÓN

## TEL

<b>Guerrero</b>	VITROMEX	Av. Ejido 26 calle 4 No. 26 Col. Bellavista C.P. 39550 Acapulco de Juarez.	<b>(744) 156-1535</b>
<b>Guerrero</b>	MUEBLES PARA BAÑO S.A. DE C.V.	Blvrd. De las naciones Km. 13.5 Col. La poza, Acapulco Gro. C.P. 39906	<b>(744) 433-2312</b> <b>(744) 433-2313</b>
<b>Zihuatanejo</b>	URBANA RAMÍREZ ACEVEDO	Av. Morelos S/N Col. Centro, Municipio Zihuatanejo Azueta, C.P. 40880	<b>(755) 55-43430</b>
<b>Oaxaca</b>	DEPÓSITO ELÉCTRICO Y DISTRIBUCIONES DE TUBOS Y CONEXIONES DE OAXACA	Xicoténcatl No. 204, Col. Centro, Oaxaca Oax. C.P. 68000	<b>(951) 514-11-11</b> <b>(951) 502-13-40</b>
<b>Oaxaca</b>	PRODUCTO MORA S.A. DE C.V.	Bahía de Sta Cruz, No. 109, sector T, Santa María Huatulco, Oaxaca C.P. 70989	<b>(958) 5870-234</b>
<b>Cuautla</b>	MAYORISTAS EN PLOMERIA Y MUEBLES PARA BAÑO S.A. DE C.V.	Defensa del agua y San Martin No. 27, Col. Centro Cuautla Morelos, C.P. 62740	<b>(735) 352-6402</b> <b>(735) 352-3496</b>
<b>Tlaxcala</b>	FERRETERÍA BAÑOS Y AZULEJOS DE TLAXCALA S.A. DE C.V.	Sucursal vía corta San Pablo Macro, carretera Federal Santa Ana apizaco Km 30+730 C.P. 90600	<b>(246) 46-872-65</b>
<b>Celaya</b>	CASA BLANCA	Av. Tecnológico 680 Col. Las aves Celaya Gto.	<b>(461) 679 3009</b>
<b>San Miguel de Allende</b>	GRUPO FERRETERO DON PEDRO	Carretera San Miguel a Celaya KM 2.4 Poblado de don Diego C.P: 37887 San Miguel de Allende, Gto	<b>(415) 152 1714</b>
<b>Pachuca</b>	LLANO DE LA TORRE	Carr. Cd. Sahagún-Pachuca No. 1350 Col. El saucillo C.P. 42186 Mineral de Reforma Hidalgo	<b>(771) 689 0140</b> <b>(771) 689 0141</b> <b>(771) 689 0142</b>

## ZONA SURESTE

<b>Cancún</b>	EL FLUXÓMETRO DE CANCÚN S.A. DE C.V.	Av. Xel-Ha No. 89 SM-25 Mz 21 Lote 33, Col. Centro, Cancún Quintana Roo, C.P. 77509	<b>(998) 887-1036</b>
<b>Cancún</b>	EL FLUXÓMETRO DE CANCÚN S.A. DE C.V.	Blv. Luis Donald Colosio 2000 Local 1 Mz. 3 Lt 17-02 Sm-57, Municipio de Benito Juárez, Cancún, Quintana Roo	<b>(998) 889-9950</b>
<b>Cancún</b>	MUEBLES PARA BAÑO S.A. DE C.V.	Av. José López Portillo Lt. 1 Mz. 60 sm 91 Cancún, C.P. 77516	<b>(998) 891-9777</b>
<b>Cancún</b>	MUEBLES PARA BAÑO S.A. DE C.V.	Av. López Portillo Lt. 36 MZ 66 SMZ58 Col Unidad Morelos, Cancún Quinta Roo 77500	<b>(998) 898-8041</b> <b>(998) 891-9777</b>
<b>Cancún</b>	PLOBAÑOS DEL SUR S.A DE C.V	Carr. Cancún Aeropuerto Km. 9 central de bodegas Cancún 15 y 16 Col. Alfredo V. Bonfil C.P. 77560	<b>(998) 887-0421</b> <b>al 24</b>
<b>Cancún</b>	MATERAMA S.A. DE C.V.	Av. López Portillo Lt. 10 Sp M 102 y 61, Del. Benito Juárez, C.P. 77517, Cancún Q. Roo	<b>(998) 8937905</b> <b>(998) 8935212</b>
<b>Cancún</b>	EL NIPLITO	Av. José López Portillo, Super mz. 98, MZ. 51,lote 3, Cancún Quintana Roo C.P. 77500	<b>(938) 3828165</b>
<b>Mérida</b>	CEREBRA	Calle 59 D X 104 Jacinto Canek No. 381 Mérida C.P. 97230	<b>(999) 945 0003</b>

**ESTADO****DISTRIBUIDOR****DIRECCIÓN****TEL**

<b>Mérida</b>	EL NIPLITO	Calle 60 no. 709 C.P. 97000 Col. Centro Mérida Yucatán	<b>(999) 924 3934</b>
<b>Mérida</b>	EL NIPLITO	Anillo Periférico tablaje catastral 13951, entrada en carretera a Dzitya, Mérida Yucatán C.P. 97200	<b>(999) 930 0630</b>
<b>Mérida</b>	MAYOREO CÉRAMICO DE LA PENÍNSULA S.A. DE C.V. (MCP)	Periférico Sur Km 1 No. 461, Col. El Roble, Mérida Yucatán C.P. 97255	<b>(999) 946 0315</b>
<b>Playa del Carmen</b>	EL NIPLITO	Carretera Federal Cancún - Tulum 140 lt. 2 y 3 Municipio Solidaridad, Playa del Carmen Quintana Roo C.P. 77710	<b>(984) 859 3218</b> <b>(984) 859 3222</b> <b>(984) 859 3223</b>
<b>Cozumel</b>	EL NIPLITO	65 Av. Sur con primera entre Av. Rosado Salas No. 148 Col. L. pez Mateos, Cozumel, Quintana Roo C.P. 77667	<b>(987) 872 7590</b> <b>(987)872 7704</b>
<b>Chetumal</b>	EL NIPLITO	Av. Andrés Quintana Roo no. 356, Col. Taxistas, Municipio Othon P. Blanco, Chetumal Quintana Roo C.P. 77037	<b>(983) 285 3078</b> <b>(983) 285 3079</b>
<b>Valladolid</b>	EL NIPLITO	Calle 42 no. 201 x 45 esquina Valladolid Yucatán C.P. 97780	<b>(985) 856 1751</b>
<b>Campeche</b>	EL NIPLITO	Av. José López Portillo No. 224, San Francisco de Campeche, Campeche. C.P. 24090	<b>(981) 145 1524</b>
<b>Ciudad del carmen</b>	EL NIPLITO	Av. Juárez No. 214 x 35 B, Col. Fatima, Ciudad del Carmen, Campeche. C.P. 24110	<b>(938) 3828165</b> <b>(938) 3827776</b>
<b>Chiapas</b>	MERCANTIL DEL CONSTRUCTOR S.A. DE C.V.	5ta Av.Norte #734 Esq. 7 poniente Col. Barrio Colón C.P 29000 Tuxtla Gutierrez	<b>(961) 600-2012</b> <b>(961) 600-2013</b>
<b>Chiapas</b>	MERCANTIL DEL CONSTRUCTOR S.A. DE C.V.	14 Calle Pte. No. 4, Centro, Tapachula Chiapas C.P. 30700	<b>(962) 626-1050</b> <b>(962) 626-9590</b>
<b>Chiapas</b>	MERPISOS S.A. DE C.V	Periferico Sur Poniente No. 334 C.P. 29060, Col. Santa Elena, Tuxtla Gutierrez Chiapas	<b>(961) 602-9333</b> <b>(961) 602-9066</b> <b>(961) 602-9266</b>
<b>Chiapas</b>	MATERIALES DE LOS ALTOS	Juan Sabines Gutiérrez, No. 6, Barrio de San Diego, C.P. 29270. San Cristóbal de las Casas.	<b>(967) 678-4700</b>
<b>Tabasco</b>	COMERCIALIZADORA DE POLVOS Y ACEROS (BOHAUS)	Avenida Niños Heroes No. 107 Col. Atasta, C.P : 86100, Villahermosa, Tabasco	<b>(993) 131 1995</b>

**Z O N A B A J Í O**

<b>Guadalajara</b>	SERVICIO DE REFACCIONES EL FLUXOMETRO S.A. DE C.V.	Av. Niños Héroeos No. 2129, Col. Unión Obrera, Guadalajara Jal. C.P. 44150	<b>(333) 616-8639</b>
<b>Guadalajara</b>	REFACCIONARIA FERRETERA S.A. DE C.V.	González Gallo No. 660, Col. San Carlos Sector Reforma, Guadalajara Jal. C.P. 44460	<b>(333) 619-3015</b> <b>(333) 619-3090</b>
<b>Guadalajara</b>	NUEVA FERRETERA JIMENEZ S.A DE C.V.	Escorza No. 575, Col. Barrera, Zona Centro Guadalajara Jal. C.P. 44150	<b>(333) 8259412</b> <b>(333) 8263232</b> <b>(333) 8256818</b>
<b>Guadalajara</b>	ARKIRAMICA S.A DE C.V	Carretera a Tepic 5324 Las Juntas 48291 Puerto Vallarta, Jalisco	<b>(322) 290-3237</b>

**ESTADO****DISTRIBUIDOR****DIRECCIÓN****TEL**

<b>Guadalajara</b>	EL FLUXÓMETRO DE VALLARTA S.A. DE C.V.	Av. Libramiento No. 130-A, Col. Lázaro Cárdenas, Puerto Vallarta Jal. C.P. 48300	<b>(322) 222-4026</b> <b>(322) 222-4022</b>
<b>Tepic</b>	KURODA PLOMERIA Y AZULEJOS S.A. DE C.V.	Av. Mar egeo no. 1 Col. Simancas Tepic Nayarit	<b>(311) 688 1292</b>
<b>Guanajuato</b>	AGUALUZ S.A. DE C.V.	Bld. Campestre No. 35-loc 2, Col. La Florida, León Guanajuato C.P. 37470	<b>(477) 779-5047</b> <b>(477) 779-5089</b>
<b>Guanajuato</b>	GALO S.A DE C.V	Bld. Hidalgo No. 1408, Fraccionamiento Hidalgo C.P. 37220 León Guanajuato	<b>(477) 71 86513</b> <b>(477) 71 84141</b> <b>(477) 71 84037</b>
<b>Guanajuato</b>	LIMSA S.A DE C.V.	Bld. Campestre No. 35 esq. Bld. Hidalgo, La florida C.P. 37190 León Guanajuato	<b>(477) 170 -2705</b>
<b>Aguascalientes</b>	LA INDUSTRIAL MEXICANA S.A. DE C.V.	Av. De la Convención Sur #1400, esq. Ayuntamiento, Col. Caminero C.P. 20270, Aguascalientes, Ags.	<b>(449) 910-5006</b>
<b>Michoacán</b>	ISIDRO OVEJAS S.A. DE C.V.	Av. Lázaro Cárdenas No. 1191-A , Col. Centro, Morelia Michoacán, C.P. 58150	<b>(443) 317-3043</b> <b>(443) 334-1091</b>
<b>Michoacán</b>	REMODELA	Calle Gertrudis Boca Negra No. 861, Ventura Puente Morelia	<b>(443) 315-9231</b>
<b>Michoacán</b>	MORALES ACOSTA DANIEL	Libramiento Km. 5.5 Lt. 3, Mz. 2 Col. Independencia C.P. 60950 Lázaro Cárdenas	<b>(753) 532-2977</b> <b>(753) 537-7123</b>
<b>Zacatecas</b>	EL TRIANGULO SURTIDOR S.A. DE C.V.	Bld. López Mateos 509, Col. Pánfilo Natera, Zacatecas, C.P. 98070	<b>(492) 922-4578</b> <b>(492) 922-2638</b> <b>(492) 922-2659</b>
<b>Colima</b>	MODA CERAMICA S.A. DE C.V	Av. Venustiano Carranza 1745, Col. Residencial Esmeralda, C.P : 28017, Colima, Colima	<b>(312) 323 7636</b> <b>(312) 315 2418</b>

**ZONA N O R E S T E**

<b>Monterrey</b>	PISOS Y PLOMERIA DEL NORTE S.A. DE C.V.	Av. Madero No. 1046 Poniente, Col. Centro, Monterrey N. L. C.P. 64000	<b>(818) 375-0133</b> <b>(818) 375-1365</b>
<b>Monterrey</b>	CASA SANITARIOS Y AZULEJOS S.A. DE C.V.	Av. Aarón Saénz No. 1895, Col Sta. María, Monterrey Nvo. León C.P. 64650	<b>(818) 346-1692</b>
<b>Monterrey</b>	BAÑOS Y DECORACIONES S.A DE C.V.	Av. Vasconcelos 390 Ote Col. Del Valle C.P. 66220 San Pedro Garza Garcia N.L.	<b>(818) 3566 940</b>
<b>Monterrey</b>	LEONCIO MEDRANO TORRES	Av. Colón No. 2330 Poniente, Col. Centro, Monterrey Nvo. León, C.P. 64000	<b>(818) 333-0062</b> <b>(818) 347-5933</b>
<b>Monterrey</b>	PLOMERIA GARCIA S.A. DE C.V.	Av. Madero No. 1031 Pte. Esq. Villagrán, Col. Centro, Monterrey N. L. C.P. 64000	<b>(81) 15222 100</b>
<b>Coahuila</b>	VACO Y CONEXIONES S.A. DE C.V.	Urduñola Norte No.250, Esq. Umbol, Col. Centro, Saltillo Coah. C.P. 25000	<b>(844) 410-3808</b> <b>(844) 410-4744</b>
<b>Coahuila</b>	AZULEJOS BAÑOS Y CONEXIONES S.A. DE C.V.	Matamoros 185 Poniente, Col. Centro, Torreón Coah. C.P. 27000	<b>(871) 716-8660</b> <b>(871) 716-8663</b>



**ESTADO****DISTRIBUIDOR****DIRECCIÓN****TEL**

<b>Coahuila</b>	GRUPO COMERCIAL CASTA O S.A. DE C.V.	Blvd. Guerrero No. 2035 Sur Vistahermosa, Cd. Acuña Coah. C.P. 26200	<b>(877) 772-4121</b>
<b>Tamaulipas</b>	M.N. DEL GOLFO S.A. DE C.V.	Av. De la Industria No. 14320, Col. Laguna de la Puerta, Altamira, C.P. 89603	<b>(833) 230-1414</b>
<b>Tamaulipas</b>	SANITARIOS Y MATERIALES DE MADERO S.A. DE C.V.	Av. Ejercito Mexicano. Esq. 1º de Mayo S/N, Col. Loma del Gallo, Cd. Madero Tamps. C.P. 89460	<b>(833) 210-3030</b>
<b>Tamaulipas</b>	PLOMERÍA FIERRO Y SANITARIOS	Mina oriente #1001, Ciudad Victoria Tamaulipas, C.P. 87000	<b>(834) 316-8525</b>
<b>Durango</b>	MARÍA DEL REFUGIO	Calle Victoria Sur No. 420 Col. Centro, Durango C.P. 34000	<b>(618) 8121 489</b>
<b>Durango</b>	FERRETERIA DURANGO	20 De Noviembre No. 514 Ote, Centro, Durango Durango , C.P. 34000	<b>(618) 812-2002</b> <b>(618) 835-2500</b>
<b>Durango</b>	TUBERIA Y LÁMINA DE DURANGO	Av. 20 de Noviembre 214 ote. Durango Dgo. C.P. 34000	<b>(618) 811-2830</b> <b>ext.101</b> <b>618 813 6393</b>
<b>Durango</b>	FERREBAÑOS GUADIANA	Blvd. Durango 1222 Col. Fracc. La Pradera, Durango, Durango, C.P. 34150	<b>(618) 813 2000</b>
<b>Durango</b>	GUTIÉRREZ FERRETERO	Blvd. Miguel Alemán y Rayon S/N Col. Centro Gómez Palacio Durango C.P. 35000	<b>(871) 1751 200</b>
<b>San Luis Potosí</b>	PLOMERÍA SELECTA S.A. DE C.V	Santos Degollado No. 1090 Col. Barrio de Tequisquiapan, San Luis Potosí S.L.P C.P. 78270	<b>(444) 813-3090</b> <b>(444) 813-4204</b>
<b>San Luis Potosí</b>	PLOMERÍA POTOSINA S.A. DE C.V.	Tomasa Estévez No. 1100, Col. Alamitos San Luis Potosí C.P. 78280	<b>(444) 812-7927</b>

**ZONA PACÍFICO**

<b>Sinaloa</b>	MARÍA ESTELA KURODA SAN (CASA KURODA)	Obregón No. 302 Sur, Col. centro, Culiacán Sin. C.P. 80000	<b>(667) 712-1235</b> <b>(667) 712-1452</b>
<b>Sinaloa</b>	KURODA PLOMERIA Y AZULEJOS S.A DE C.V.	Carreta internacional s/n Y Flamingos Fracc. Campo Bello, Mazatlán Sin. C.P. 82010	<b>(669) 985-0028</b> <b>(669) 985-0029</b>
<b>Sinaloa</b>	KS MAYOREO	Periférico Pte. No 81-A, Col Raquet Club, Hermosillo Sonora C.P. 83190	<b>(662) 218-5888</b> <b>(662) 218-7085</b>
<b>Sonora</b>	KURODA NORTE S.A. DE C.V	Blvd. Josefa Ortiz de Domínguez No.322, Col. Centro, C.P. 83550, Puerto Peñasco, Sonora	<b>(638) 388-1291</b> <b>(638) 388-1290</b>
<b>Sonora</b>	IVICEVIC	Calz. García López No. 915 entre toba y delicias C.P. 85420 guaymas	<b>(622) 222 0512</b>
<b>Sonora</b>	TUBERIAS Y VALVULAS SONORA	5 de Febrero No 763 Sur, Col. Centro, Cd. Obregón Son. C.P. 85000 Blvd. Lázaro Cárdenas	<b>(644) 416-7665</b> <b>(644) 416-8560</b>
<b>B.C.N.</b>	KURODA NORTE S.A. DE C.V.	No 640 Ote. Col. Ex ejido Coahuila, Mexicali B.C.N. C.P. 21360	<b>(686) 500-2020</b>





# NUESTROS SERVICIO POST-VENTA DE REFACCIONES



LÍNEA TELEFÓNICA

**(55) 5333 9421**



CHAT EN VIVO

**En nuestro sitio web**



EMAIL

**refacciones@helvex.com.mx**



MENSAJES WHATSAPP

**55 8071 7454**



**refaccioneshelvex.com.mx**







**Helvex, S.A. de C.V.**, Calzada Coltongo 293, Colonia Industrial Vallejo, 02300.  
CDMX, Servicio y asistencia de refacciones **Tel.: 55 5333 - 9421**

 **HelvexOficial**

 **@HelvexMx**

 **@HelvexMx**

 **55 8071 7454**

**refaccioneshelvex.com.mx**



**helvex.com.mx**

